

Channel Selection Chart23

P1000 (12 Gauge)24 - 29

P1100 (14 Gauge)30 - 32

P2000 (16 Gauge)33 - 35

P3000 (12 Gauge)36 - 38

P3300 (12 Gauge)39 - 41

P4000 (16 Gauge)42 - 44

P4100 (14 Gauge)45 - 47

P4400 (12 Gauge)48 - 50

P4520 (12 Gauge)51 - 53

P5000 (12 Gauge)54 - 56

P5500 (12 Gauge)57 - 59

Closure Strips60

End Caps and Frame Caps61

Lateral Bracing Load Reduction Chart & Bearing Loads.....62

MATERIAL

Unistrut channels are accurately and carefully cold formed to size from low-carbon strip steel.

All spot-welded combination members, except P1001T, are welded 3" (76 mm) maximum on center.

STEEL: PLAIN

12 Ga. (2.7 mm), 14 Ga.(1.9 mm) and 16 Ga. (1.5 mm) ASTM A1011 SS GR 33.

STEEL: PRE-GALVANIZED

12 Ga. (2.7 mm), 14 Ga. (1.9 mm) and 16 Ga. (1.5mm) ASTM A653 GR 33.

For other materials, see Special Metals or Fiberglass sections.

FINISHES

All channels are available in:

- Perma Green III (GR).
- Pre-galvanized (PG), conforming to ASTM A653 G90.
- Hot-dipped galvanized (HG), conforming to ASTM A123.
- Plain (PL).

DIMENSIONS

Imperial dimensions are illustrated in inches. Metric dimensions are shown in millimeters and rounded to one decimal place.

STANDARD LENGTHS

Standard lengths are 10 feet (3.05m) and 20 feet (6.10m). Tolerances are ±1/8" (3 mm). Special lengths are available for a small cutting charge with a tolerance of ±1/8" (3 mm).

CURVED CHANNEL

Contact your local Unistrut Service Center or Unistrut Corporation for more information.

LOAD DATA

All beam and column load data pertains to carbon steel and stainless steel channels. Load tables and charts are constructed to be in accordance with the SPECIFICATION FOR THE DESIGN OF COLD-FORMED STEEL STRUCTURAL MEMBERS 2007 EDITION published by the AMERICAN IRON AND STEEL INSTITUTE USING ASD METHOD. Loads are based on 33 ksi steel cold formed to 42 ksi.

Type of Load	Safety Factor to Yield Strength	Safety Factor to Ultimate Strength
Beam Loads	1.67	2.0
Column Load	1.80	2.2



1 5/8" Channel

Telestrut

Nuts & Hardware

General Fittings

Pipe/Conduit Supports

Electrical Fittings

Concrete Inserts

Solar

Unipier®

P1000 Series (12 ga.)

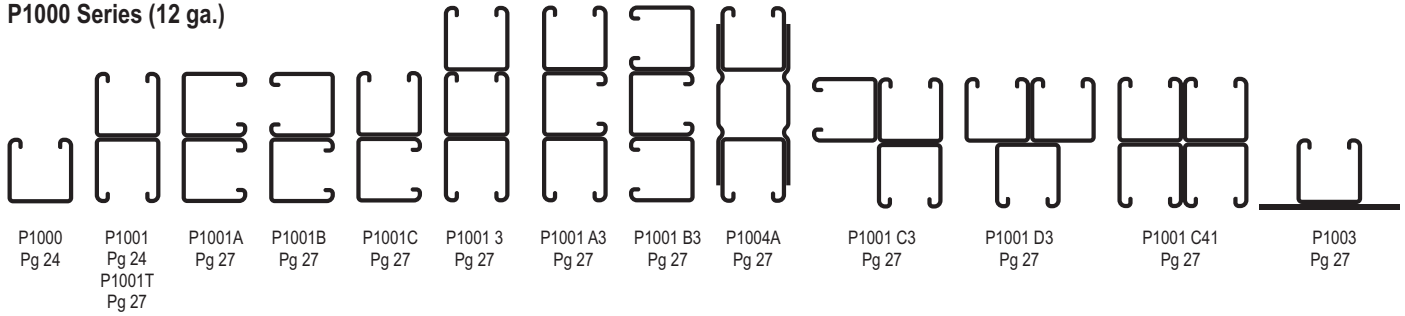

P1100 Series (14 ga.)

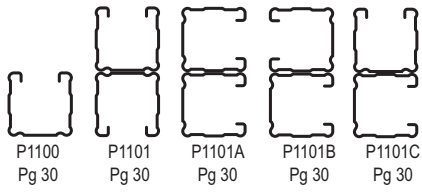

P2000 Series (16 ga.)

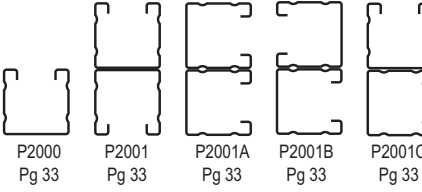

P3000 Series (12 ga.)

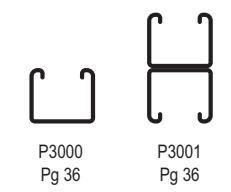

P3300 Series (12 ga.)

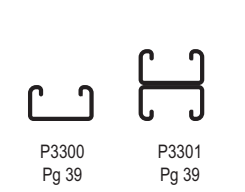

P4100 Series (14 ga.)

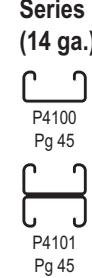

P4000 Series (16 ga.)

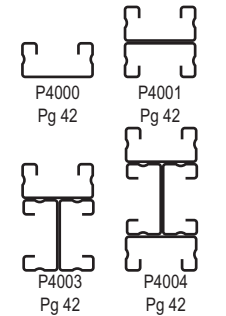

P4400 Series (12 ga.)



P4520 Series (12 ga.)



P5000 Series (12 ga.)

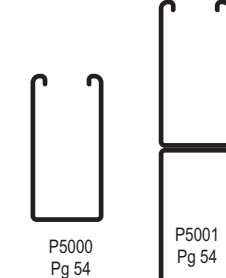

P5500 Series (12 ga.)

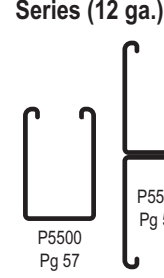

P9000 Series (12 ga.) Telestrut Channel

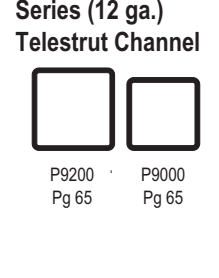

End Caps and Frame Caps

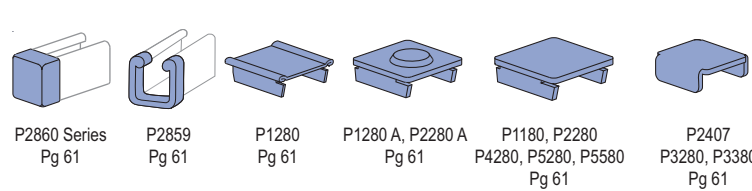

1 5/8" Channel Closure Strips

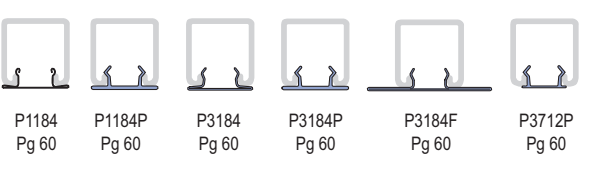

Alternate Framing Systems

A1000 Series (14 gauge) – 1 1/4" Channel

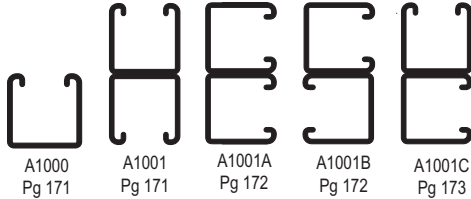

A3300 Series (14 gauge) 1 1/4" Channel

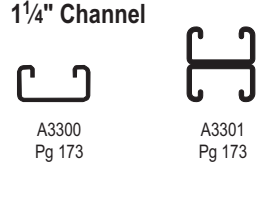

A4000 Series (19 gauge) 1 1/4" Channel

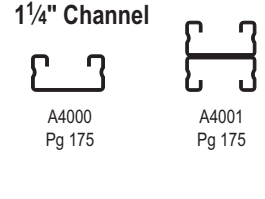

A5000 Series (14 gauge) 1 1/4" Channel

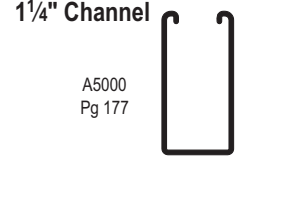

P6000 Series (19 gauge) – 1 3/16" Channel

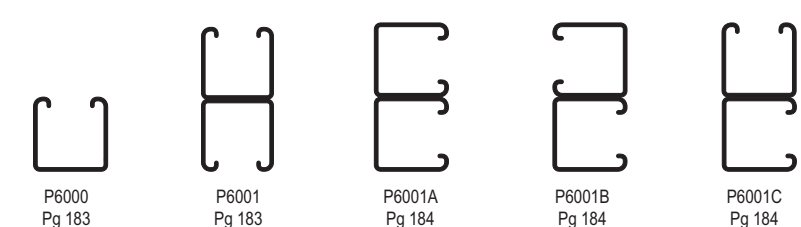

P7000 Series (19 gauge) 1 3/16" Channel

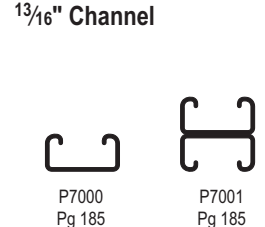

CHANNEL SELECTION CHART

Channel	Channel Dimensions		Material & Thickness			Hole Pattern Styles					
			Steel gauge	Stainless Steel gauge	Alum. In (mm)						
	Width In (mm)	Height In (mm)				HS	T	Steel Only			H3
P1000	1½ (41.3)	1½ (41.3)	12 ga	12 ga	0.109 (2.8)	■	■	■	■	■	■
P1100	1½ (41.3)	1½ (41.3)	14 ga	14 ga	—	■	■	■	■	—	—
P2000	1½ (41.3)	1½ (41.3)	16 ga	—	—	■	■	■	■	—	—
P3000	1½ (41.3)	1¾ (34.9)	12 ga	—	—	■	■	■	■	—	—
P3300	1½ (41.3)	7/8 (22.2)	12 ga	12 ga	—	■	■	—	■	—	—
P4000	1½ (41.3)	1⅜ (20.6)	16 ga	16 ga	0.078 (2.0)	■	■	—	■	—	—
P4100	1½ (41.3)	1⅜ (20.6)	14 ga	—	—	■	■	—	■	—	—
P4400	1½ (41.3)	1 (25.4)	12 ga	—	—	■	■	—	■	—	—
P4520	1½ (41.3)	1⅜ (20.6)	12 ga	—	—	■	■	—	■	—	—
P5000	1½ (41.3)	3¼ (82.6)	12 ga	12 ga	—	■	■	■	■	—	—
P5500	1½ (41.3)	2⅞ (61.9)	12 ga	—	0.109 (2.8)	■	■	■	■	—	—

CHANNELS & COMBINATIONS IN DESCENDING ORDER OF STRENGTH

Channel	Area In ² (cm ²)	Weight lbs/ft (kg/m)	I In ⁴ (cm ⁴)	s In ³ (cm ³)	Allow. Moment In-lbs (N*m)
P5001	1.793 11.57	6.10 9.1	6.227 259.2	1.916 31.4	48,180 5,440
P1004A	1.965 12.68	6.68 9.9	4.068 169.3	1.669 27.4	41,980 4,740
P5501	1.452 9.37	4.94 7.3	2.805 116.8	1.151 18.9	28,940 3,270
P1001C41	2.221 14.33	7.55 11.2	1.856 77.2	1.142 18.7	28,720 3,250
P5000	0.897 5.78	3.05 4.5	1.098 45.7	0.627 10.3	15,770 1,780
P1001	1.111 7.16	3.78 5.6	0.928 38.6	0.571 9.4	14,360 1,620
P1101	0.835 5.39	2.84 4.2	0.733 30.5	0.451 7.4	11,340 1,280
P3001	1.000 6.45	3.40 5.1	0.591 24.6	0.430 7.0	10,810 1,220
P5500	0.726 4.68	2.47 3.7	0.522 21.7	0.390 6.4	9,820 1,110
P2001	0.684 4.41	2.32 3.5	0.618 25.7	0.381 6.2	9,570 1,080
P9200	0.489 3.16	2.23 3.3	0.279 11.6	0.297 4.9	7,480 850
A5000	0.492 3.17	1.67 2.5	0.358 14.9	0.265 4.3	6,670 750
P4401	0.849 5.48	5.77 8.5	0.26 10.6	0.26 4.2	6,410 725
A1001	0.609 3.93	2.07 3.1	0.302 12.6	0.242 4.0	6,070 690
P9000	0.387 2.50	1.88 2.8	0.166 6.9	0.205 3.4	5,150 580
P1000	0.555 3.58	1.89 2.8	0.185 7.7	0.202 3.3	5,070 570
P3301	0.790 5.10	2.69 4.0	0.176 7.3	0.201 3.3	5,060 570
P4521	0.77 4.97	2.62 3.9	0.15 6.1	0.18 2.9	4,538 513

Channel	Area In ² (cm ²)	Weight lbs/ft (kg/m)	I In ⁴ (cm ⁴)	s In ³ (cm ³)	Allow. Moment In-lbs (N*m)
P1100	0.418 2.69	1.42 2.1	0.145 6.0	0.162 2.6	4,060 460
P3000	0.500 3.23	1.70 2.5	0.120 5.0	0.153 2.5	3,850 430
P4101	0.579 3.74	1.97 2.9	0.117 4.9	0.143 2.4	3,610 410
P2000	0.342 2.21	1.16 1.7	0.125 5.2	0.140 2.3	3,520 400
P4001	0.478 3.14	1.66 2.5	0.104 4.3	0.128 2.1	3,210 360
A3301	0.459 2.96	1.56 2.3	0.077 3.2	0.103 1.7	2,590 290
P4400	0.424 2.74	2.89 4.3	0.053 2.2	0.092 1.5	2,300 260
A1000	0.305 1.96	1.04 1.5	0.061 2.5	0.086 1.4	2,170 250
P3300	0.395 2.55	1.34 2.0	0.037 1.5	0.072 1.2	1,800 200
P4520	0.384 2.48	1.31 1.9	0.031 1.3	0.064 1.0	1,615 183
A4001	0.264 1.70	0.90 1.3	0.037 1.5	0.058 1.0	1,470 170
P6001	0.213 1.38	0.73 1.1	0.045 1.9	0.055 0.9	1,400 160
P4100	0.290 1.87	0.98 1.5	0.026 1.1	0.054 0.9	1,360 150
P4000	0.244 1.57	0.83 1.2	0.023 0.9	0.049 0.8	1,230 140
A3300	0.230 1.48	0.78 1.2	0.017 0.7	0.038 0.6	950 110
A4000	0.132 0.85	0.45 0.7	0.008 0.3	0.022 0.4	560 60
P6000	0.107 0.69	0.36 0.5	0.009 0.4	0.020 0.3	510 60
P7001	0.148 0.96	0.50 0.8	0.007 0.3	0.018 0.3	460 50
P7000	0.074 0.48	0.25 0.4	0.002 0.1	0.007 0.1	170 20

Combinations not shown in catalog are available on special order. Consult factory for more details.



Unipier® Solar Concrete Inserts Electrical Fittings Pipe/Conduit Supports General Fittings Nuts & Hardware Telestrut Channel 1 5/8" Channel

P1000®

GR HG PG PL

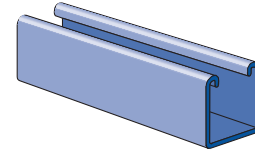
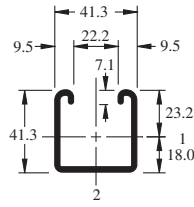
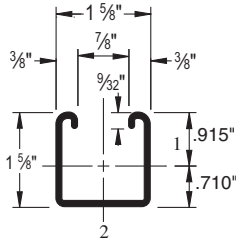

Wt/100 Ft: 189 Lbs (281 kg/100 m)
 Allowable Moment 5,070 In-Lbs (570 N*m)
 12 Gauge Nominal Thickness .105" (2.7mm)

P1001

GR HG PG PL

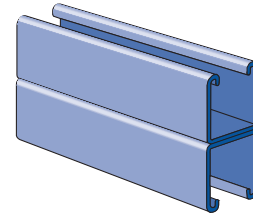
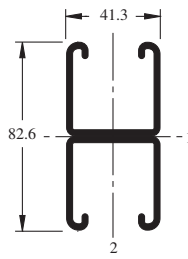
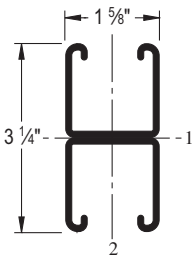

Wt/100 Ft: 378 Lbs (562 kg/100 m)
 Allowable Moment 14,360 In-Lbs (1,620 N*m)
 12 Gauge Nominal Thickness .105" (2.7mm)

P1000 DS

P1000 H3

GR HG PG PL

P1000 HS

GR HG PG PL

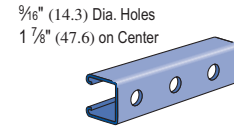
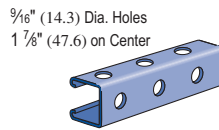
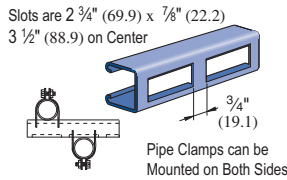

Wt/100 Ft: 173 Lbs (257 kg/100 m)

Wt/100 Ft: 175 Lbs (260 kg/100 m)

Wt/100 Ft: 185 Lbs (275 kg/100 m)

P1000 KO

GR PG

P1000 SL

GR HG PG PL

P1000 T

GR HG PG PL

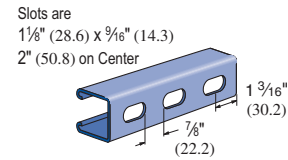
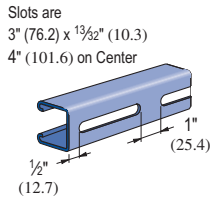
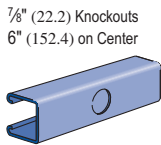

Wt/100 Ft: 190 Lbs (283 kg/100 m)

Wt/100 Ft: 185 Lbs (275 kg/100 m)

Wt/100 Ft: 185 Lbs (275 kg/100 m)

CHANNEL NUTS (REFER TO PAGES 73,74 FOR DETAILS)

SEE PAGE 73, 74

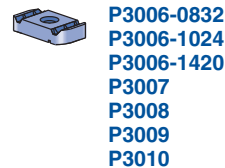
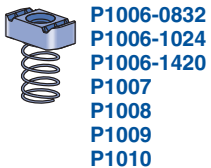

Channel Finishes: PL, GR, HG, PG, ZD; Standard Lengths: 10' & 20'

P1000 - BEAM LOADING

Span In	Max. Allowable Uniform Load Lbs	Defl. at Uniform Load In	Uniform Loading at Deflection		
			Span/180 Lbs	Span/240 Lbs	Span/360 Lbs
24	1,690	0.06	1,690	1,690	1,690
36	1,130	0.13	1,130	1,130	900
48	850	0.22	850	760	500
60	680	0.35	650	480	320
72	560	0.50	450	340	220
84	480	0.68	330	250	160
96	420	0.89	250	190	130
108	380	1.14	200	150	100
120	340	1.40	160	120	80
144	280	2.00	110	80	60
168	240	2.72	80	60	40
192	210	3.55	60	50	NR
216	190	4.58	50	40	NR
240	170	5.62	40	NR	NR

P1001 - BEAM LOADING

Span In	Max. Allowable Uniform Load Lbs	Defl. at Uniform Load In	Uniform Loading at Deflection		
			Span/180 Lbs	Span/240 Lbs	Span/360 Lbs
24	3,500*	0.02	3,500*	3,500*	3,500*
36	3,190	0.07	3,190	3,190	3,190
48	2,390	0.13	2,390	2,390	2,390
60	1,910	0.20	1,910	1,910	1,620
72	1,600	0.28	1,600	1,600	1,130
84	1,370	0.39	1,370	1,240	830
96	1,200	0.51	1,200	950	630
108	1,060	0.64	1,000	750	500
120	960	0.79	810	610	410
144	800	1.14	560	420	280
168	680	1.53	410	310	210
192	600	2.02	320	240	160
216	530	2.54	250	190	130
240	480	3.16	200	150	100

P1000 - COLUMN LOADING

Unbraced Height In	Max. Allowable Load at Slot Face Lbs	Maximum Column Load Applied at C.G.			
		K = 0.65 Lbs	K = 0.80 Lbs	K = 1.0 Lbs	K = 1.2 Lbs
24	3,550	10,740	9,890	8,770	7,740
36	3,190	8,910	7,740	6,390	5,310
48	2,770	7,260	6,010	4,690	3,800
60	2,380	5,910	4,690	3,630	2,960
72	2,080	4,840	3,800	2,960	2,400
84	1,860	4,040	3,200	2,480	1,980
96	1,670	3,480	2,750	2,110	1,660
108	1,510	3,050	2,400	1,810	**
120	1,380	2,700	2,110	**	**
144	1,150	2,180	1,660	**	**

P1001 - COLUMN LOADING

Unbraced Height In	Max. Allowable Load at Slot Face Lbs	Maximum Column Load Applied at C.G.			
		K = 0.65 Lbs	K = 0.80 Lbs	K = 1.0 Lbs	K = 1.2 Lbs
24	6,430	24,280	23,610	22,700	21,820
36	6,290	22,810	21,820	20,650	19,670
48	6,160	21,410	20,300	18,670	16,160
60	6,000	20,210	18,670	15,520	12,390
72	5,620	18,970	16,160	12,390	8,950
84	5,170	16,950	13,630	9,470	6,580
96	4,690	14,890	11,190	7,250	5,040
108	4,170	12,850	8,950	5,730	3,980
120	3,690	10,900	7,250	4,640	**
144	2,930	7,630	5,040	**	**

P1000/P1001 - ELEMENTS OF SECTION

Parameter	P1000		P1001	
Area of Section	0.555	In ²	1.111	In ²
Axis 1-1				
Moment of Inertia (I)	0.185	In ⁴	0.928	In ⁴
Section Modulus (S)	0.202	In ³	0.571	In ³
Radius of Gyration (r)	0.577	In	0.914	In
Axis 2-2				
Moment of Inertia (I)	0.236	In ⁴	0.471	In ⁴
Section Modulus (S)	0.290	In ³	0.580	In ³
Radius of Gyration (r)	0.651	In	0.651	In

Notes:

* Load limited by spot weld shear.

** KL/r > 200

NR = Not Recommended.

- Beam loads are given in total uniform load (W Lbs) not uniform load (w lbs/ft or w lbs/in).
- Beam loads are based on a simple span and assumed to be adequately laterally braced. Unbraced spans can reduce beam load carrying capacity. Refer to Page 62 for reduction factors for unbraced lengths.
- For pierced channel, multiply beam loads by the following factor:

"KO" Series.....95%	"T" Series85%
"HS" Series90%	"SL" Series85%
"H3" Series.....90%	"DS" Series.....70%
- Deduct channel weight from the beam loads.
- For concentrated midspan point loads, multiply beam loads by 50% and the corresponding deflection by 80%. For other load conditions refer to page 18.
- All beam loads are for bending about Axis 1-1.

1 5/8" Channel
Telestrut
Nuts & Hardware
General Fittings
Pipe/Conduit Supports
Electrical Fittings
Concrete Inserts
Solar
Unipier®

P1000 - BEAM LOADING (METRIC)

Span mm	Max Allowable Uniform Load kN	Defl. at Uniform Load mm	Uniform Loading at Deflection		
			Span/180 kN	Span/240 kN	Span/360 kN
600	7.6	1	7.6	7.6	7.6
750	6.1	2	6.1	6.1	5.9
1,000	4.6	4	4.6	4.6	3.3
1,250	3.6	6	3.6	3.2	2.1
1,500	3.1	9	3.0	2.2	1.5
1,750	2.6	12	2.2	1.6	1.1
2,000	2.3	15	1.6	1.2	0.8
2,500	1.8	24	1.1	0.8	0.5
3,000	1.5	34	0.8	0.5	0.4
3,500	1.3	46	0.5	0.4	0.3
4,000	1.2	62	0.4	0.3	0.2
4,500	1.0	78	0.3	0.3	0.2
5,000	0.9	97	0.3	0.2	NR
6,000	0.8	136	0.2	NR	NR

P1001 - BEAM LOADING (METRIC)

Span mm	Max Allowable Uniform Load kN	Defl. at Uniform Load mm	Uniform Loading at Deflection		
			Span/180 kN	Span/240 kN	Span/360 kN
600	15.6 *	1	15.6 *	15.6 *	15.6 *
750	15.6 *	1	15.6 *	15.6 *	15.6 *
1,000	13.0	2	13.0	13.0	13.0
1,250	10.4	3	10.4	10.4	10.4
1,500	8.7	5	8.7	8.7	7.4
1,750	7.4	7	7.4	7.4	5.5
2,000	6.5	9	6.5	6.3	4.2
2,500	5.2	13	5.2	4.0	2.7
3,000	4.3	19	3.7	2.8	1.9
3,500	3.7	26	2.8	2.0	1.4
4,000	3.2	34	2.1	1.6	1.1
4,500	2.9	44	1.6	1.2	0.8
5,000	2.6	53	1.3	1.0	0.7
6,000	2.2	78	0.9	0.7	0.4

P1000 - COLUMN LOADING (METRIC)

Unbraced Height mm	Maximum Allowable Load at Slot Face kN	Maximum Column Load Applied at C.G.			
		K = 0.65 kN	K = 0.80 kN	K = 1.0 kN	K = 1.2 kN
600	15.8	48.0	44.3	39.4	34.8
750	15.2	44.0	39.4	33.8	28.9
1,000	13.7	37.5	32.0	26.1	21.3
1,250	12.1	31.6	26.1	20.3	16.5
1,500	10.7	26.7	21.3	16.5	13.4
1,750	9.6	22.7	17.8	13.8	11.3
2,000	8.7	19.3	15.3	11.9	9.6
2,250	7.9	16.9	13.4	10.4	8.2
2,500	7.2	15.0	11.9	9.1	**
2,750	6.7	13.5	10.6	8.1	**

P1001 - COLUMN LOADING (METRIC)

Unbraced Height mm	Maximum Allowable Load at Slot Face kN	Maximum Column Load Applied at C.G.			
		K = 0.65 kN	K = 0.80 kN	K = 1.0 kN	K = 1.2 kN
600	28.6	108.2	105.3	101.3	97.4
750	28.3	105.0	101.3	96.5	92.2
1,000	27.8	99.6	95.0	89.7	83.9
1,250	27.3	94.7	89.7	81.7	70.1
1,500	26.8	90.3	83.9	70.1	56.4
1,750	25.4	86.7	74.8	58.6	43.5
2,000	23.9	79.4	65.5	47.7	33.3
2,250	22.2	71.9	56.4	37.9	26.3
2,500	20.4	64.4	47.7	30.7	21.3
2,750	18.5	56.9	39.6	25.4	17.6

P1000/P1001 - ELEMENTS OF SECTION (METRIC)

Parameter	P1000	P1001
Area of Section	3.58 cm ²	7.16 cm ²
Axis 1-1		
Moment of Inertia (I)	7.68 cm ⁴	38.62 cm ⁴
Section Modulus (S)	3.30 cm ³	9.36 cm ³
Radius of Gyration (r)	1.46 cm	2.32 cm
Axis 2-2		
Moment of Inertia (I)	9.80 cm ⁴	19.60 cm ⁴
Section Modulus (S)	4.75 cm ³	9.50 cm ³
Radius of Gyration (r)	1.65 cm	1.65 cm

Notes:

* Load limited by spot weld shear.

** KL/r > 200

NR = Not Recommended.

- Beam loads are given in total uniform load (W Lbs) not uniform load (w lbs/ft or w lbs/in).
- Beam loads are based on a simple span and assumed to be adequately laterally braced. Unbraced spans can reduce beam load carrying capacity. Refer to Page 62 for reduction factors for unbraced lengths.
- For pierced channel, multiply beam loads by the following factor:

"KO" Series.....95%	"T" Series85%
"HS" Series90%	"SL" Series85%
"H3" Series.....90%	"DS" Series.....70%
- Deduct channel weight from the beam loads.
- For concentrated midspan point loads, multiply beam loads by 50% and the corresponding deflection by 80%. For other load conditions refer to page 18.
- All beam loads are for bending about Axis 1-1.

P1001 T

GR PG

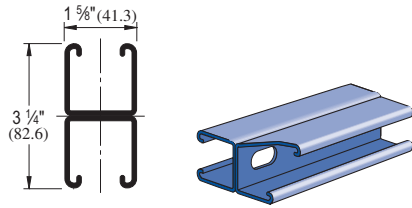

Wt/100 Ft: 321 Lbs (478 kg/100 m)
 Allowable Moment 12,200 In-Lbs (1,378 N•m)
 12 Gauge Nominal Thickness .105" (2.7mm)

P1001 A

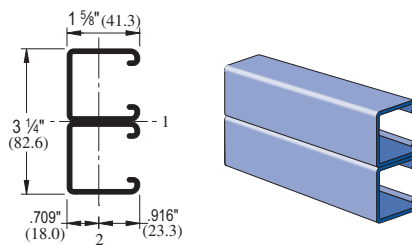

Wt/100 Ft: 378 Lbs (562 kg/100 m)
 Allowable Moment 18,640 In-Lbs (2,110 N•m)
 12 Gauge Nominal Thickness .105" (2.7mm)

P1001 B

GR PG

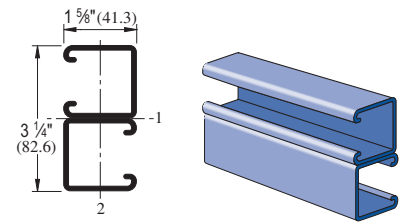

Wt/100 Ft: 378 Lbs (562 kg/100 m)
 Allowable Moment 18,640 In-Lbs (2,110 N•m)
 12 Gauge Nominal Thickness .105" (2.7mm)

P1001 C

GR PG

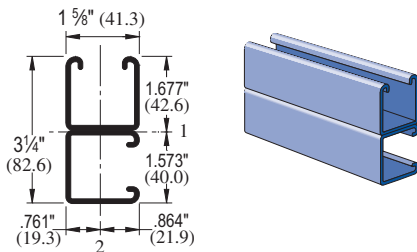

Wt/100 Ft: 378 Lbs (562 kg/100 m)
 Allowable Moment 15,950 In-Lbs (1,800 N•m)
 12 Gauge Nominal Thickness .105" (2.7mm)

P1001 3

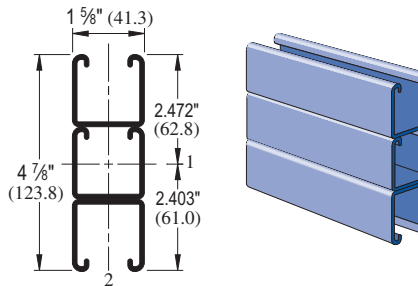

Wt/100 Ft: 566 Lbs (843 kg/100 m)
 Allowable Moment 31,840 In-Lbs (3,600 N•m)
 12 Gauge Nominal Thickness .105" (2.7mm)

P1001 A3

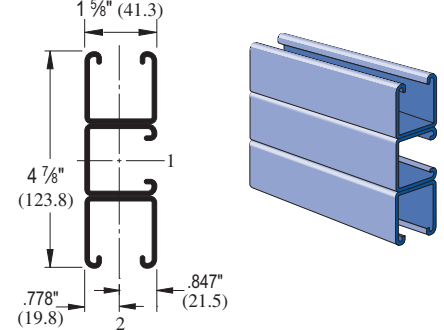

Wt/100 Ft: 566 Lbs (843 kg/100 m)
 Allowable Moment 32,770 In-Lbs (3,700 N•m)
 12 Gauge Nominal Thickness .105" (2.7mm)

P1001 B3

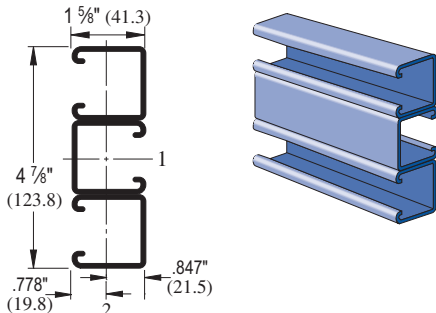

Wt/100 Ft: 566 Lbs (843 kg/100 m)
 Allowable Moment 37,550 In-Lbs (4,240 N•m)
 12 Gauge Nominal Thickness .105" (2.7mm)

P1001 D3

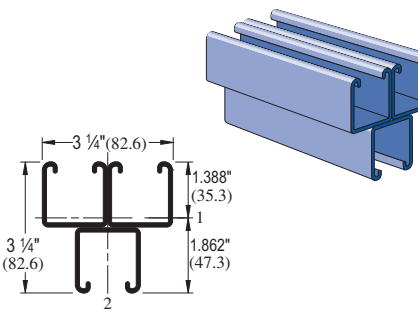

Wt/100 Ft: 566 Lbs (843 kg/100 m)
 Allowable Moment 17,550 In-Lbs (1,980 N•m)
 12 Gauge Nominal Thickness .105" (2.7mm)

P1003

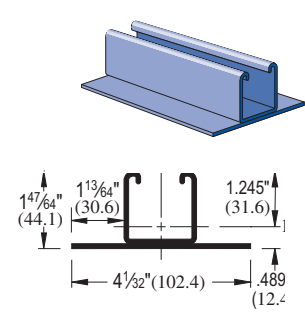

Wt/100 Ft: 333 Lbs (495 kg/100 m)
 Allowable Moment 6,240 In-Lbs (700 N•m)
 12 Gauge Nominal Thickness .105" (2.7mm)

P1001 C41

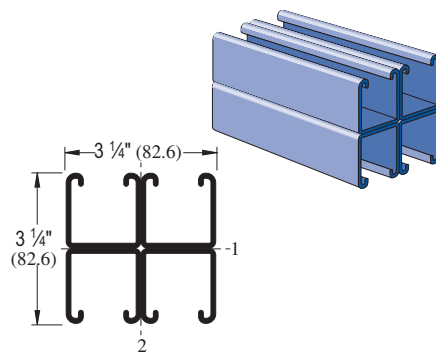

Wt/100 Ft: 755 Lbs (1,124 kg/100 m)
 Allowable Moment 28,720 In-Lbs (3,250 N•m)
 12 Gauge Nominal Thickness .105" (2.7mm)

P1001 C3

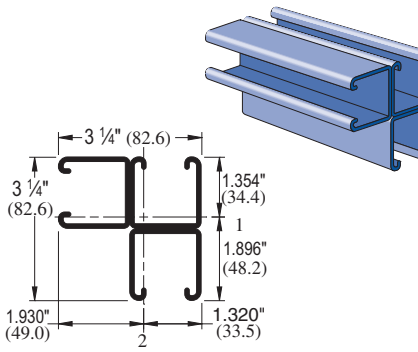

Wt/100 Ft: 566 Lbs (843 kg/100 m)
 Allowable Moment 18,680 In-Lbs (2,110 N•m)
 12 Gauge Nominal Thickness .105" (2.7mm)

P1004 A

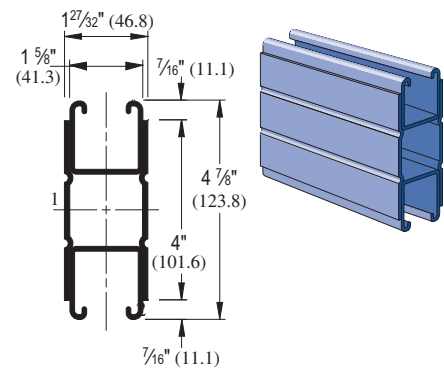

Wt/100 Ft: 668 Lbs (994 kg/100 m)
 Allowable Moment 41,970 In-Lbs (4,740 N•m)
 12 Gauge Nominal Thickness .105" (2.7mm)

Channel Finishes: PL, GR, HG, PG, ZD; Standard Lengths: 10' & 20'

1 5/8" Channel
 Telestrut
 Nuts & Hardware
 General Fittings
 Pipe/Conduit Supports
 Electrical Fittings
 Concrete Inserts
 Solar
 Unipier®

P1001 C41 - BEAM LOADING

Span In	Max Allowable Uniform Load Lbs	Defl. at Uniform Load In	Uniform Loading at Deflection		
			Span/180 Lbs	Span/240 Lbs	Span/360 Lbs
24	7,040*	0.02	7,040*	7,040*	7,040*
36	6,380	0.07	6,380	6,380	6,380
48	4,790	0.13	4,790	4,790	4,790
60	3,830	0.20	3,830	3,830	3,240
72	3,190	0.28	3,190	3,190	2,250
84	2,740	0.39	2,740	2,480	1,660
96	2,390	0.50	2,390	1,900	1,270
108	2,130	0.64	2,000	1,500	1,000
120	1,910	0.78	1,620	1,220	810
144	1,600	1.14	1,130	840	560
168	1,370	1.55	830	620	410
192	1,200	2.02	630	480	320
216	1,060	2.54	500	380	250
240	960	3.16	410	300	200

P1004 A - BEAM LOADING

Span In	Max Allowable Uniform Load Lbs	Defl. at Uniform Load In	Uniform Loading at Deflection		
			Span/180 Lbs	Span/240 Lbs	Span/360 Lbs
24	9,100*	0.01	9,100*	9,100*	9,100*
36	9,100*	0.05	9,100*	9,100*	9,100*
48	7,000	0.08	7,000	7,000	7,000
60	5,600	0.13	5,600	5,600	5,600
72	4,660	0.19	4,660	4,660	4,660
84	4,000	0.26	4,000	4,000	3,630
96	3,500	0.34	3,500	3,500	2,780
108	3,110	0.43	3,110	3,110	2,200
120	2,800	0.52	2,800	2,670	1,780
144	2,330	0.75	2,330	1,850	1,230
168	2,000	1.03	1,810	1,360	910
192	1,750	1.34	1,390	1,040	690
216	1,550	1.69	1,100	820	550
240	1,400	2.10	890	670	440

P1001 C41 - COLUMN LOADING

Unbraced Height In	Maximum Allowable Load at Slot Face Lbs	Maximum Column Load Applied at C.G.			
		K = 0.65 Lbs	K = 0.80 Lbs	K = 1.0 Lbs	K = 1.2 Lbs
24	12,690	46,920	44,980	42,360	39,890
36	12,250	42,680	39,890	36,660	34,050
48	11,820	38,740	35,720	32,640	30,430
60	11,470	35,500	32,640	29,980	28,220
72	11,180	32,970	30,430	28,220	26,820
84	10,900	31,040	28,840	27,010	24,870
96	10,580	29,570	27,680	26,170	19,840
108	10,310	28,440	26,820	22,310	15,670
120	10,070	27,560	26,170	18,280	12,700
144	8,740	26,320	19,840	12,700	8,820
168	7,360	21,890	14,570	9,330	**

P1004 A - COLUMN LOADING

Unbraced Height In	Maximum Allowable Load at Slot Face Lbs	Maximum Column Load Applied at C.G.			
		K = 0.65 Lbs	K = 0.80 Lbs	K = 1.0 Lbs	K = 1.2 Lbs
24	11,420	36,800	33,890	30,440	27,600
36	10,600	30,840	27,600	24,400	22,160
48	9,860	26,400	23,560	21,060	19,470
60	9,160	23,370	21,060	19,160	18,020
72	8,610	21,310	19,470	18,020	17,140
84	8,170	19,890	18,410	17,260	15,240
96	7,790	18,890	17,670	16,760	11,670
108	7,460	18,160	17,140	13,280	9,220
120	7,150	17,590	16,760	10,750	7,470
144	5,660	16,840	11,670	7,470	**
168	4,520	12,990	8,570	**	**

P1001 C41/ P1004 A - ELEMENTS OF SECTION

Parameter	P1001 C41	P1004 A
Area of Section	2.221 In ²	1.965 In ²
Axis 1-1		
Moment of Inertia (I)	1.856 In ⁴	4.068 In ⁴
Section Modulus (S)	1.142 In ³	1.669 In ³
Radius of Gyration (r)	0.914 In	1.439 In
Axis 2-2		
Moment of Inertia (I)	2.408 In ⁴	1.092 In ⁴
Section Modulus (S)	1.482 In ³	1.190 In ³
Radius of Gyration (r)	1.041 In	0.745 In

Notes:

* Load limited by spot weld shear.

** KL/r > 200

NR = Not Recommended.

- Beam loads are given in total uniform load (W Lbs) not uniform load (w lbs/ft or w lbs/in).
- Beam loads are based on a simple span and assumed to be adequately laterally braced. Unbraced spans can reduce beam load carrying capacity. Refer to Page 62 for reduction factors for unbraced lengths.
- For pierced channel, multiply beam loads by the following factor:
"KO" Series 95% **"T" Series 85%**
"HS" Series 90% **"SL" Series 85%**
- Deduct channel weight from the beam loads.
- For concentrated midspan point loads, multiply beam loads by 50% and the corresponding deflection by 80%. For other load conditions refer to page 18.
- All beam loads are for bending about Axis 1-1.

P1001 C41 - BEAM LOADING (METRIC)

Span mm	Max Allowable Uniform Load kN	Defl. at Uniform Load mm	Uniform Loading at Deflection		
			Span/180 kN	Span/240 kN	Span/360 kN
600	31.3 *	1	31.3 *	31.3 *	31.3 *
750	31.3 *	1	31.3 *	31.3 *	31.3 *
1,000	26.0	2	26.0	26.0	26.0
1,250	20.8	3	20.8	20.8	20.8
1,500	17.3	5	17.3	17.3	14.9
1,750	14.8	7	14.8	14.8	10.9
2,000	13.0	9	13.0	12.6	8.4
2,500	10.4	13	10.4	8.1	5.4
3,000	8.7	19	7.4	5.6	3.7
3,500	7.4	26	5.5	4.1	2.8
4,000	6.5	34	4.2	3.2	2.1
4,500	5.8	44	3.3	2.5	1.6
5,000	5.2	54	2.7	2.0	1.3
6,000	4.3	77	1.9	1.4	0.9

P1004 A - BEAM LOADING (METRIC)

Span mm	Max Allowable Uniform Load kN	Defl. at Uniform Load mm	Uniform Loading at Deflection		
			Span/180 kN	Span/240 kgN	Span/360 kN
600	40.5 *	1	40.5 *	40.5 *	40.5 *
750	40.5 *	1	40.5 *	40.5 *	40.5 *
1,000	37.9	2	37.9	37.9	37.9
1,250	30.3	3	30.3	30.3	30.3
1,500	25.3	4	25.3	25.3	25.3
1,750	21.7	6	21.7	21.7	21.7
2,000	18.9	9	18.9	18.9	18.4
2,500	15.2	13	15.2	15.2	11.7
3,000	12.6	18	12.6	12.2	8.2
3,500	10.9	23	10.9	9.0	6.0
4,000	9.5	29	9.2	6.9	4.6
4,500	8.5	36	7.2	5.4	3.6
5,000	7.6	52	5.9	4.4	2.9
6,000	6.3	77	4.1	3.1	2.0

P1001 C41 - COLUMN LOADING (METRIC)

Unbraced Height mm	Maximum Allowable Load at Slot Face kN	Maximum Column Load Applied at C.G.			
		K = 0.65 kN	K = 0.80 kN	K = 1.0 kN	K = 1.2 kN
600	56.5	209.3	200.8	189.3	178.4
750	55.6	200.1	189.3	175.8	164.1
1,000	53.9	184.7	171.7	157.3	146.1
1,250	52.4	170.7	157.3	143.8	134.1
1,500	51.1	158.9	146.1	134.1	126.1
1,750	50.0	149.3	137.6	127.3	120.7
2,000	49.2	141.5	131.1	122.3	116.8
2,250	47.9	135.4	126.1	118.6	101.9
2,500	46.8	130.4	122.3	114.5	83.9
2,750	45.9	126.4	119.2	98.8	69.4

P1004 A - COLUMN LOADING (METRIC)

Unbraced Height mm	Maximum Allowable Load at Slot Face kN	Maximum Column Load Applied at C.G.			
		K = 0.65 kN	K = 0.80 kN	K = 1.0 kN	K = 1.2 kN
600	50.9	164.6	151.8	136.5	123.8
750	49.1	150.8	136.5	121.1	109.5
1,000	46.3	130.9	116.9	103.4	94.3
1,250	43.5	115.8	103.4	92.6	85.8
1,500	40.9	104.8	94.3	85.8	80.6
1,750	38.9	96.8	88.1	81.3	77.0
2,000	37.1	91.0	83.7	78.1	74.8
2,250	35.7	86.6	80.6	75.8	60.9
2,500	34.3	83.3	78.1	71.1	49.4
2,750	33.1	80.7	76.2	58.8	40.8

P1001 C41/ P1004 A - ELEMENTS OF SECTION (METRIC)

Parameter	P1001 C41	P1004 A
Area of Section	14.33 cm ²	12.68 cm ²
Axis 1-1		
Moment of Inertia (I)	77.24 cm ⁴	169.33 cm ⁴
Section Modulus (S)	18.71 cm ³	27.35 cm ³
Radius of Gyration (r)	2.32 cm	3.66 cm
Axis 2-2		
Moment of Inertia (I)	100.24 cm ⁴	45.44 cm ⁴
Section Modulus (S)	24.29 cm ³	19.50 cm ³
Radius of Gyration (r)	2.64 cm	1.89 cm

Notes:

* Load limited by spot weld shear.

** KL/r > 200

NR = Not Recommended.

- Beam loads are given in total uniform load (W Lbs) not uniform load (w lbs/ft or w lbs/in).
- Beam loads are based on a simple span and assumed to be adequately laterally braced. Unbraced spans can reduce beam load carrying capacity. Refer to Page 62 for reduction factors for unbraced lengths.
- For pierced channel, multiply beam loads by the following factor:

"KO" Series95%	"T" Series85%
"HS" Series90%	"SL" Series85%
- Deduct channel weight from the beam loads.
- For concentrated midspan point loads, multiply beam loads by 50% and the corresponding deflection by 80%. For other load conditions refer to page 18.
- All beam loads are for bending about Axis 1-1.



1 5/8" Channel
 Telestrut
 Nuts & Hardware
 General Fittings
 Pipe/Conduit Supports
 Electrical Fittings
 Concrete Inserts
 Solar
 Unipier®

P1100

GR PG

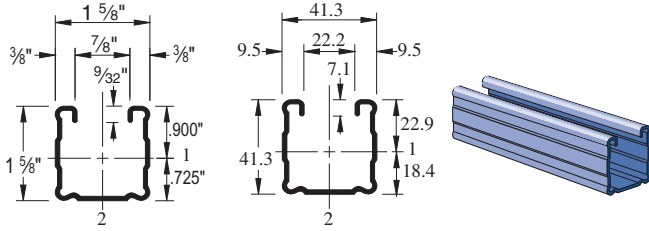

Wt/100 Ft: 142 Lbs (211 kg/100 m)
 Allowable Moment 4,060 In-Lbs (460 N•m)
 14 Gauge Nominal Thickness .075" (1.9mm)

P1101

GR PG

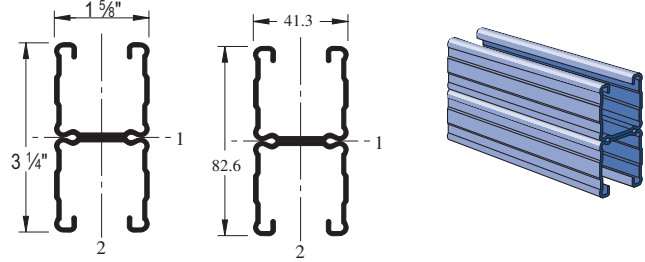

Wt/100 Ft: 284 Lbs (423 kg/100 m)
 Allowable Moment 11,340 In-Lbs (1,280 N•m)
 14 Gauge Nominal Thickness .075" (1.9mm)

P1101 A

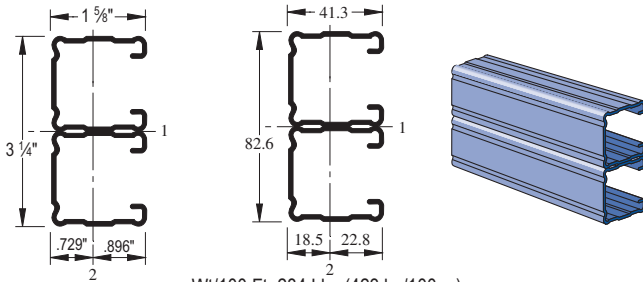

Wt/100 Ft: 284 Lbs (423 kg/100 m)
 Allowable Moment 14,000 In-Lbs (1,580 N•m)
 14 Gauge Nominal Thickness .075" (1.9mm)

P1101 B

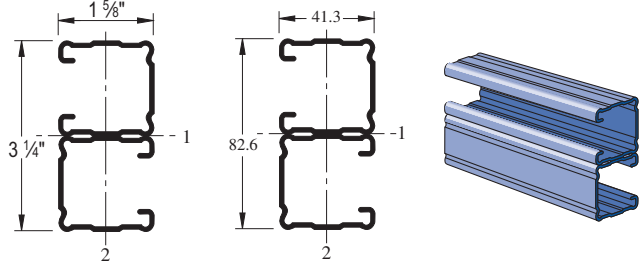

Wt/100 Ft: 284 Lbs (423 kg/100 m)
 Allowable Moment 14,000 In-Lbs (1,580 N•m)
 14 Gauge Nominal Thickness .075" (1.9mm)

P1101 C

GR PG

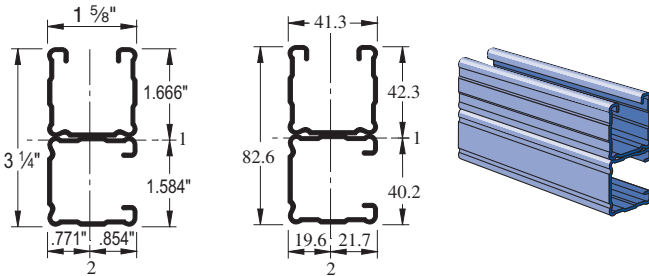

Wt/100 Ft: 284 Lbs (423 kg/100 m)
 Allowable Moment 12,330 In-Lbs (1,390 N•m)
 14 Gauge Nominal Thickness .075" (1.9mm)

P1100 HS

GR PG

9/16" (14.3) Dia. Holes
 1 7/8" (47.6) on Center

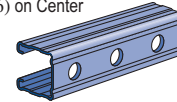

Wt/100 Ft: 136 Lbs (202 kg/100 m)

P1100 KO

GR PG

7/8" (22.2) Knockouts
 6" (152.4) on Center

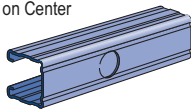

Wt/100 Ft: 140 Lbs (208 kg/100 m)

P1100 SL

GR PG

Slots are
 3" (76.2) x 1 1/2" (10.3)
 4" (101.6) on Center

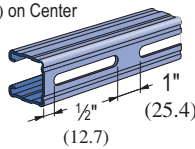

Wt/100 Ft: 136 Lbs (202 kg/100 m)

P1100 T

GR PG

Slots are
 1 1/8" (28.6) x 9/16" (14.3)
 2" (50.8) on Center

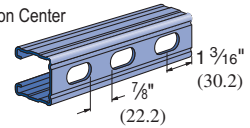

Wt/100 Ft: 136 Lbs (202 kg/100 m)

CHANNEL NUTS (REFER TO PAGES 73,74 FOR DETAILS)

SEE PAGE 73, 74

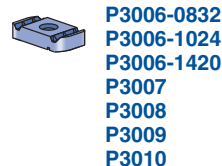
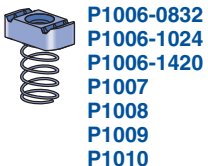

Channel Finishes: PL, GR, HG, PG, ZD; Standard Lengths: 10' & 20'

P1100 - BEAM LOADING

Span In	Max Allowable Uniform Load Lbs	Defl. at Uniform Load In	Uniform Loading at Deflection		
			Span/180 Lbs	Span/240 Lbs	Span/360 Lbs
24	1,350	0.06	1,350	1,350	1,350
36	900	0.13	900	900	700
48	680	0.23	680	590	400
60	540	0.36	510	380	250
72	450	0.51	350	260	180
84	390	0.70	260	190	130
96	340	0.92	200	150	100
108	300	1.15	160	120	80
120	270	1.42	130	90	60
144	230	2.09	90	70	40
168	190	2.75	60	50	30
192	170	3.67	50	40	NR
216	150	4.61	40	30	NR
240	140	5.90	30	NR	NR

P1101 - BEAM LOADING

Span In	Max Allowable Uniform Load Lbs	Defl. at Uniform Load In	Uniform Loading at Deflection		
			Span/180 Lbs	Span/240 Lbs	Span/360 Lbs
24	2,180*	0.02	2,180*	2,180*	2,180*
36	2,180*	0.06	2,180*	2,180*	2,180*
48	1,890	0.13	1,890	1,890	1,890
60	1,510	0.20	1,510	1,510	1,280
72	1,260	0.28	1,260	1,260	890
84	1,080	0.39	1,080	980	650
96	950	0.51	950	750	500
108	840	0.64	790	590	400
120	760	0.79	640	480	320
144	630	1.13	440	330	220
168	540	1.54	330	250	160
192	470	2.00	250	190	130
216	420	2.55	200	150	100
240	380	3.16	160	120	80

P1100 - COLUMN LOADING

Unbraced Height In	Maximum Allowable Load at Slot Face Lbs	Maximum Column Load Applied at C.G.			
		K = 0.65 Lbs	K = 0.80 Lbs	K = 1.0 Lbs	K = 1.2 Lbs
24	2,800	8,040	7,330	6,360	5,430
36	2,410	6,480	5,430	4,190	3,210
48	1,940	4,990	3,830	2,760	2,160
60	1,550	3,740	2,760	2,050	1,640
72	1,290	2,860	2,160	1,640	1,320
84	1,100	2,310	1,780	1,370	1,110
96	950	1,950	1,520	1,180	950
108	840	1,690	1,320	1,030	**
120	760	1,490	1,180	**	**
144	630	1,210	950	**	**

P1101 - COLUMN LOADING

Unbraced Height In	Maximum Allowable Load at Slot Face Lbs	Maximum Column Load Applied at C.G.			
		K = 0.65 Lbs	K = 0.80 Lbs	K = 1.0 Lbs	K = 1.2 Lbs
24	5,010	18,250	17,700	16,880	16,030
36	4,860	16,990	16,030	14,770	13,620
48	4,700	15,610	14,380	12,930	11,750
60	4,480	14,280	12,930	11,490	9,290
72	4,210	13,100	11,750	9,290	6,700
84	3,880	12,090	10,220	7,090	4,930
96	3,480	11,170	8,390	5,430	3,770
108	3,060	9,640	6,700	4,290	2,980
120	2,680	8,170	5,430	3,480	**
144	2,090	5,710	3,770	**	**

P1100/P1101 - ELEMENTS OF SECTION

Parameter	P1100		P1101	
Area of Section	0.418	In ²	0.835	In ²
Axis 1-1				
Moment of Inertia (I)	0.145	In ⁴	0.733	In ⁴
Section Modulus (S)	0.162	In ³	0.451	In ³
Radius of Gyration (r)	0.589	In	0.937	In
Axis 2-2				
Moment of Inertia (I)	0.176	In ⁴	0.353	In ⁴
Section Modulus (S)	0.217	In ³	0.434	In ³
Radius of Gyration (r)	0.650	In	0.650	In

Notes:

* Load limited by spot weld shear.

** KL/r > 200

NR = Not Recommended.

- Beam loads are given in total uniform load (W Lbs) not uniform load (w lbs/ft or w lbs/in).
- Beam loads are based on a simple span and assumed to be adequately laterally braced. Unbraced spans can reduce beam load carrying capacity. Refer to Page 62 for reduction factors for unbraced lengths.
- For pierced channel, multiply beam loads by the following factor:

"KO" Series	95%	"T" Series	85%
"HS" Series	90%	"SL" Series	85%
- Deduct channel weight from the beam loads.
- For concentrated midspan point loads, multiply beam loads by 50% and the corresponding deflection by 80%. For other load conditions refer to page 18.
- All beam loads are for bending about Axis 1-1.

P1100 - BEAM LOADING (METRIC)

Span mm	Max Allowable Uniform Load kN	Defl. at Uniform Load mm	Uniform Loading at Deflection		
			Span/180 kN	Span/240 kN	Span/360 kN
600	6.1	1	6.1	6.1	6.1
750	4.9	2	4.9	4.9	4.7
1,000	3.7	4	3.7	3.7	2.6
1,250	2.9	6	2.9	2.5	1.7
1,500	2.4	9	2.3	1.7	1.2
1,750	2.1	12	1.7	1.3	0.8
2,000	1.8	15	1.3	1.0	0.7
2,500	1.5	24	0.8	0.6	0.4
3,000	1.2	36	0.6	0.4	0.3
3,500	1.1	49	0.4	0.3	0.2
4,000	0.9	64	0.3	0.3	0.2
4,500	0.8	77	0.3	0.2	0.1
5,000	0.8	100	0.2	0.2	NR
6,000	0.6	143	0.1	NR	NR

P1101 - BEAM LOADING (METRIC)

Span mm	Max Allowable Uniform Load kN	Defl. at Uniform Load mm	Uniform Loading at Deflection		
			Span/180 kN	Span/240 kN	Span/360 kN
600	9.7 *	0	9.7 *	9.7 *	9.7 *
750	9.7 *	1	9.7 *	9.7 *	9.7 *
1,000	9.7 *	2	9.7 *	9.7 *	9.7 *
1,250	8.2	3	8.2	8.2	8.2
1,500	6.9	5	6.9	6.9	5.9
1,750	5.9	7	5.9	5.9	4.3
2,000	5.1	9	5.1	5.0	3.3
2,500	4.1	13	4.1	3.2	2.1
3,000	3.4	19	2.9	2.2	1.5
3,500	2.9	26	2.2	1.6	1.1
4,000	2.6	35	1.6	1.2	0.8
4,500	2.3	43	1.3	1.0	0.7
5,000	2.0	54	1.1	0.8	0.5
6,000	1.7	77	0.8	0.5	0.4

P1100 - COLUMN LOADING (METRIC)

Unbraced Height mm	Maximum Allowable Load at Slot Face kN	Maximum Column Load Applied at C.G.			
		K = 0.65 kN	K = 0.80 kN	K = 1.0 kN	K = 1.2 kN
600	12.5	35.9	32.9	28.6	24.5
750	11.8	32.6	28.6	23.5	19.0
1,000	10.1	26.9	22.0	16.4	12.5
1,250	8.5	21.6	16.4	11.8	9.3
1,500	7.0	17.0	12.5	9.3	7.4
1,750	6.0	13.5	10.1	7.7	6.2
2,000	5.2	11.2	8.6	6.5	5.3
2,250	4.6	9.6	7.4	5.7	4.7
2,500	4.1	8.4	6.5	5.1	**
2,750	3.7	7.5	5.9	4.5	**

P1101 - COLUMN LOADING (METRIC)

Unbraced Height mm	Maximum Allowable Load at Slot Face kN	Maximum Column Load Applied at C.G.			
		K = 0.65 kN	K = 0.80 kN	K = 1.0 kN	K = 1.2 kN
600	22.3	81.4	79.0	75.4	71.7
750	22.0	78.7	75.4	70.7	66.1
1,000	21.4	73.8	69.2	63.3	58.0
1,250	20.8	68.8	63.3	56.8	51.6
1,500	20.0	64.0	58.0	51.6	42.3
1,750	19.0	59.5	53.5	44.0	32.6
2,000	18.0	55.6	49.2	35.7	25.0
2,250	16.6	52.3	42.3	28.4	19.7
2,500	15.1	48.3	35.7	23.0	16.0
2,750	13.6	42.7	29.7	19.0	13.2

P1100/P1101 - ELEMENTS OF SECTION (METRIC)

Parameter	P1100		P1101	
Area of Section	2.69	cm ²	5.39	cm ²
Axis 1-1				
Moment of Inertia (I)	6.03	cm ⁴	30.51	cm ⁴
Section Modulus (S)	2.65	cm ³	7.39	cm ³
Radius of Gyration (r)	1.50	cm	2.38	cm
Axis 2-2				
Moment of Inertia (I)	7.34	cm ⁴	14.69	cm ⁴
Section Modulus (S)	3.56	cm ³	7.12	cm ³
Radius of Gyration (r)	1.65	cm	1.65	cm

Notes:

* Load limited by spot weld shear.

** KL/r > 200

NR = Not Recommended.

- Beam loads are given in total uniform load (W Lbs) not uniform load (w lbs/ft or w lbs/in).
- Beam loads are based on a simple span and assumed to be adequately laterally braced. Unbraced spans can reduce beam load carrying capacity. Refer to Page 62 for reduction factors for unbraced lengths.
- For pierced channel, multiply beam loads by the following factor:

"KO" Series	95%	"T" Series	85%
"HS" Series	90%	"SL" Series	85%
- Deduct channel weight from the beam loads.
- For concentrated midspan point loads, multiply beam loads by 50% and the corresponding deflection by 80%. For other load conditions refer to page 18.
- All beam loads are for bending about Axis 1-1.

P2000

GR PG

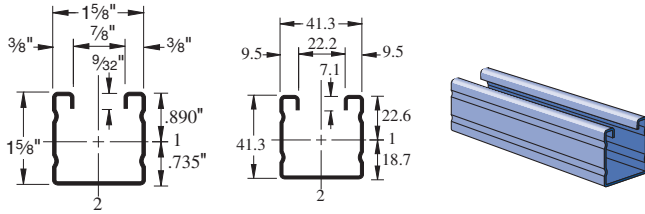

Wt/100 Ft: 116 Lbs (173 kg/100 m)
 Allowable Moment 3,520 In-Lbs (400 N•m)
 16 Gauge Nominal Thickness .060" (1.5mm)

P2001

GR PG

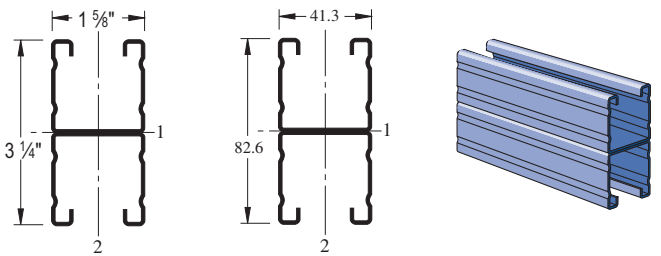

Wt/100 Ft: 232 Lbs (346 kg/100 m)
 Allowable Moment 9,570 In-Lbs (1,080 N•m)
 16 Gauge Nominal Thickness .060" (1.5mm)

P2001 A

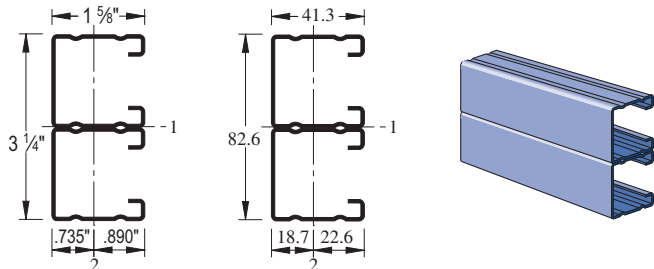

Wt/100 Ft: 232 Lbs (346 kg/100 m)
 Allowable Moment 11,660 In-Lbs (1,320 N•m)
 16 Gauge Nominal Thickness .060" (1.5mm)

P2001 B

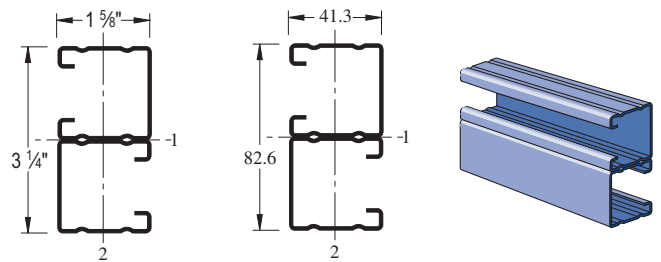

Wt/100 Ft: 232 Lbs (346 kg/100 m)
 Allowable Moment 11,660 In-Lbs (1,320 N•m)
 16 Gauge Nominal Thickness .060" (1.5mm)

P2001 C

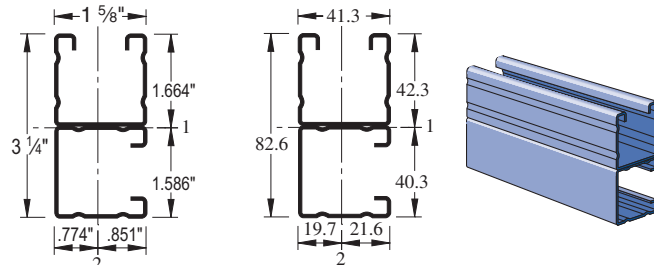

Wt/100 Ft: 232 Lbs (346 kg/100 m)
 Allowable Moment 10,350 In-Lbs (1,170 N•m)
 16 Gauge Nominal Thickness .060" (1.5mm)

P2000 HS

GR PG

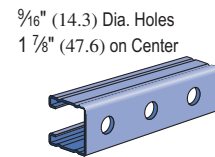

Wt/100 Ft: 113 Lbs (168 kg/100 m)

P2000 KO

GR PG

7/8" (22.2) Knockouts
 6" (152.4) on Center

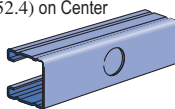

Wt/100 Ft: 117 Lbs (174 kg/100 m)

P2000 SL

GR PG

Slots are
 3" (76.2) x 1 1/2" (10.3)
 4" (101.6) on Center

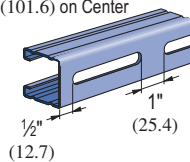

Wt/100 Ft: 113 Lbs (168 kg/100 m)

P2000 T

GR PG

Slots are
 1 1/8" (28.6) x 9/16" (14.3)
 2" (50.8) on Center

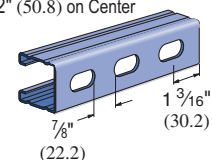

Wt/100 Ft: 113 Lbs (168 kg/100 m)

CHANNEL NUTS (REFER TO PAGES 73,74 FOR DETAILS)

SEE PAGE 73, 74

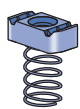

P1006-0832
P1006-1024
P1006-1420
P1007
P1008
P1009
P1010



P1008T
P1006T1420
P1010T



P1024
P1012S
P1023S



P1012
P1023
P1024S



P3006-0832
P3006-1024
P3006-1420
P3007
P3008
P3009
P3010



P3016-0632
P3016-0832
P3016-1024
P3016-1420

Channel Finishes: PL, GR, HG, PG, ZD; Standard Lengths: 10' & 20'

P2000 - BEAM LOADING

Span In	Max Allowable Uniform Load Lbs	Defl. at Uniform Load In	Uniform Loading at Deflection		
			Span/180 Lbs	Span/240 Lbs	Span/360 Lbs
24	1,170	0.06	1,170	1,170	1,170
36	780	0.13	780	780	610
48	590	0.23	590	510	340
60	470	0.36	440	330	220
72	390	0.52	300	230	150
84	340	0.71	220	170	110
96	290	0.91	170	130	90
108	260	1.16	130	100	70
120	230	1.41	110	80	50
144	200	2.12	80	60	40
168	170	2.86	60	40	30
192	150	3.76	40	30	20
216	130	4.64	30	30	NR
240	120	5.88	30	NR	NR

P2001 - BEAM LOADING

Span In	Max Allowable Uniform Load Lbs	Defl. at Uniform Load In	Uniform Loading at Deflection		
			Span/180 Lbs	Span/240 Lbs	Span/360 Lbs
24	1,610*	0.02	1,610*	1,610*	1,610*
36	1,610*	0.05	1,610*	1,610*	1,610*
48	1,600	0.13	1,600	1,600	1,600
60	1,280	0.20	1,280	1,280	1,080
72	1,060	0.28	1,060	1,060	750
84	910	0.38	910	830	550
96	800	0.51	800	630	420
108	710	0.64	670	500	330
120	640	0.79	540	410	270
144	530	1.13	380	280	190
168	460	1.56	280	210	140
192	400	2.02	210	160	110
216	350	2.52	170	130	80
240	320	3.16	140	100	70

P2000 - COLUMN LOADING

Unbraced Height In	Maximum Allowable Load at Slot Face Lbs	Maximum Column Load Applied at C.G.			
		K = 0.65 Lbs	K = 0.80 Lbs	K = 1.0 Lbs	K = 1.2 Lbs
24	2,400	6,650	6,080	5,280	4,470
36	2,050	5,380	4,470	3,370	2,500
48	1,600	4,090	3,040	2,100	1,590
60	1,230	2,960	2,100	1,500	1,160
72	970	2,190	1,590	1,160	910
84	790	1,720	1,270	950	760
96	660	1,410	1,060	800	650
108	570	1,200	910	700	**
120	510	1,040	800	620	**
144	420	830	650	**	**

P2001 - COLUMN LOADING

Unbraced Height In	Maximum Allowable Load at Slot Face Lbs	Maximum Column Load Applied at C.G.			
		K = 0.65 Lbs	K = 0.80 Lbs	K = 1.0 Lbs	K = 1.2 Lbs
24	4,200	15,030	14,600	13,940	13,220
36	4,070	14,030	13,220	12,090	10,990
48	3,920	12,850	11,720	10,290	9,040
60	3,700	11,630	10,290	8,760	7,530
72	3,410	10,460	9,040	7,530	5,740
84	3,140	9,410	7,990	6,080	4,220
96	2,890	8,490	7,120	4,650	3,230
108	2,530	7,700	5,740	3,680	2,550
120	2,210	6,950	4,650	2,980	**
144	1,690	4,890	3,230	**	**

P2000/P2001 - ELEMENTS OF SECTION

Parameter	P2000		P2001	
Area of Section	0.342	In ²	0.684	In ²
Axis 1-1				
Moment of Inertia (I)	0.125	In ⁴	0.618	In ⁴
Section Modulus (S)	0.140	In ³	0.381	In ³
Radius of Gyration (r)	0.604	In	0.951	In
Axis 2-2				
Moment of Inertia (I)	0.151	In ⁴	0.302	In ⁴
Section Modulus (S)	0.186	In ³	0.372	In ³
Radius of Gyration (r)	0.665	In	0.665	In

Notes:

* Load limited by spot weld shear.

** KL/r > 200

NR = Not Recommended.

- Beam loads are given in total uniform load (W Lbs) not uniform load (w lbs/ft or w lbs/in).
- Beam loads are based on a simple span and assumed to be adequately laterally braced. Unbraced spans can reduce beam load carrying capacity. Refer to Page 62 for reduction factors for unbraced lengths.
- For pierced channel, multiply beam loads by the following factor:

"KO" Series	95%	"T" Series	85%
"HS" Series	90%	"SL" Series	85%
- Deduct channel weight from the beam loads.
- For concentrated midspan point loads, multiply beam loads by 50% and the corresponding deflection by 80%. For other load conditions refer to page 18.
- All beam loads are for bending about Axis 1-1.

P2000 - BEAM LOADING (METRIC)

Span mm	Max Allowable Uniform Load kN	Defl. at Uniform Load mm	Uniform Loading at Deflection		
			Span/180 kN	Span/240 kN	Span/360 kN
600	5.3	1	5.3	5.3	5.3
750	4.2	2	4.2	4.2	4.0
1,000	3.2	4	3.2	3.2	2.3
1,250	2.5	6	2.5	2.2	1.4
1,500	2.1	9	2.0	1.5	1.0
1,750	1.8	12	1.5	1.1	0.8
2,000	1.6	16	1.1	0.8	0.6
2,500	1.3	25	0.7	0.5	0.4
3,000	1.1	36	0.5	0.4	0.3
3,500	0.9	47	0.4	0.3	0.2
4,000	0.8	63	0.3	0.2	0.1
4,500	0.7	80	0.2	0.2	0.1
5,000	0.6	96	0.2	0.1	0.1
6,000	0.5	142	0.1	NR	NR

P2001 - BEAM LOADING (METRIC)

Span mm	Max Allowable Uniform Load kN	Defl. at Uniform Load mm	Uniform Loading at Deflection		
			Span/180 kN	Span/240 kN	Span/360 kN
600	7.2 *	0	7.2 *	7.2 *	7.2 *
750	7.2 *	1	7.2 *	7.2 *	7.2 *
1,000	7.2 *	2	7.2 *	7.2 *	7.2 *
1,250	6.9	3	6.9	6.9	6.9
1,500	5.8	5	5.8	5.8	5.0
1,750	4.9	7	4.9	4.9	3.6
2,000	4.3	9	4.3	4.2	2.8
2,500	3.5	13	3.5	2.7	1.8
3,000	2.9	19	2.5	1.9	1.2
3,500	2.5	27	1.8	1.4	0.9
4,000	2.2	35	1.4	1.1	0.7
4,500	1.9	43	1.1	0.8	0.5
5,000	1.7	54	0.9	0.7	0.4
6,000	1.4	76	0.6	0.4	0.3

P2000 - COLUMN LOADING (METRIC)

Unbraced Height mm	Maximum Allowable Load at Slot Face kN	Maximum Column Load Applied at C.G.			
		K = 0.65 kN	K = 0.80 kN	K = 1.0 kN	K = 1.2 kN
600	10.7	29.8	27.3	23.8	20.2
750	10.1	27.0	23.8	19.3	15.3
1,000	8.5	22.3	18.0	12.9	9.6
1,250	6.9	17.6	12.9	9.0	6.8
1,500	5.6	13.5	9.6	6.8	5.2
1,750	4.6	10.5	7.6	5.5	4.3
2,000	3.8	8.5	6.2	4.6	3.6
2,250	3.3	7.1	5.2	4.0	3.2
2,500	2.8	6.1	4.6	3.5	2.8
2,750	2.5	5.3	4.1	3.1	**

P2001 - COLUMN LOADING (METRIC)

Unbraced Height mm	Maximum Allowable Load at Slot Face kN	Maximum Column Load Applied at C.G.			
		K = 0.65 kN	K = 0.80 kN	K = 1.0 kN	K = 1.2 kN
600	18.7	67.0	65.1	62.2	59.1
750	18.4	64.9	62.2	58.3	54.2
1,000	17.9	61.0	56.9	51.5	46.3
1,250	17.3	56.6	51.5	45.0	39.5
1,500	16.5	52.1	46.3	39.5	34.0
1,750	15.5	47.9	41.6	34.8	27.9
2,000	14.5	43.9	37.5	30.4	21.3
2,250	13.6	40.2	34.0	24.3	16.9
2,500	12.5	37.0	30.4	19.7	13.7
2,750	11.3	34.2	25.4	16.3	11.3

P2000/P2001 - ELEMENTS OF SECTION (METRIC)

Parameter	P2000	P2001
Area of Section	2.21 cm ²	4.41 cm ²
Axis 1-1		
Moment of Inertia (I)	5.19 cm ⁴	25.74 cm ⁴
Section Modulus (S)	2.29 cm ³	6.24 cm ³
Radius of Gyration (r)	1.53 cm	2.42 cm
Axis 2-2		
Moment of Inertia (I)	6.29 cm ⁴	12.58 cm ⁴
Section Modulus (S)	3.05 cm ³	6.10 cm ³
Radius of Gyration (r)	1.69 cm	1.69 cm

Notes:

* Load limited by spot weld shear.

** KL/r > 200

NR = Not Recommended.

- Beam loads are given in total uniform load (W Lbs) not uniform load (w lbs/ft or w lbs/in).
- Beam loads are based on a simple span and assumed to be adequately laterally braced. Unbraced spans can reduce beam load carrying capacity. Refer to page 62 for reduction factors for unbraced lengths.
- For pierced channel, multiply beam loads by the following factor:
"KO" Series95% **"T" Series85%**
"HS" Series90% **"SL" Series85%**
- Deduct channel weight from the beam loads.
- For concentrated midspan point loads, multiply beam loads by 50% and the corresponding deflection by 80%. For other load conditions refer to page 18.
- All beam loads are for bending about Axis 1-1.



1 5/8" Channel
Telestrut
Nuts & Hardware
General Fittings
Pipe/Conduit Supports
Electrical Fittings
Concrete Inserts
Solar
Unipier®

P3000

GR PG

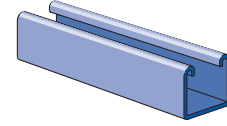
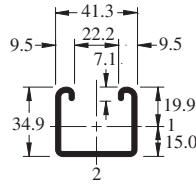
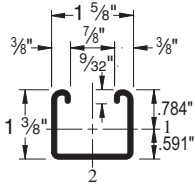

Wt/100 Ft: 170 Lbs (253 kg/100 m)
Allowable Moment 3,840 In-Lbs (430 N*m)
12 Gauge Nominal Thickness .105" (2.7mm)

P3001

GR PG

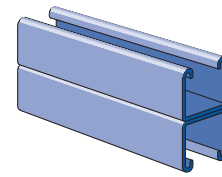
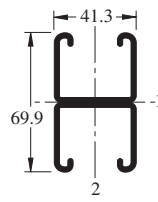
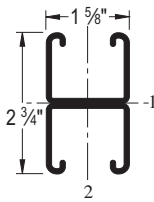

Wt/100 Ft: 340 Lbs (506 kg/100 m)
Allowable Moment 10,810 In-Lbs (1,220 N*m)
12 Gauge Nominal Thickness .105" (2.7mm)

P3000 HS

GR PG

9/16" (14.3) Dia. Holes
1 7/8" (47.6) on Center

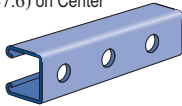

Wt/100 Ft: 165 Lbs (246 kg/100 m)

P3000 KO

GR PG

7/8" (22.2) Knockouts
6" (152.4) on Center

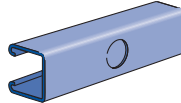

Wt/100 Ft: 170 Lbs (253 kg/100 m)

P3000 SL

GR PG

Slots are
3" (76.2) x 1 1/2" (10.3)
4" (101.6) on Center

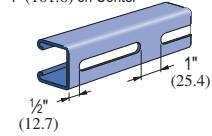

Wt/100 Ft: 165 Lbs (246 kg/100 m)

P3000 T

GR PG

Slots are
1 1/8" (28.6) x 9/16" (14.3)
2" (50.8) on Center

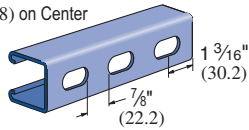

Wt/100 Ft: 165 Lbs (246 kg/100 m)

CHANNEL NUTS (REFER TO PAGES 73,74 FOR DETAILS)

SEE PAGE 73, 74



P1006-0832
P1006-1024
P1006-1420
P1007
P1008
P1009
P1010



P1008T
P1006T1420
P1010T



P1024
P1012S
P1023S



P3006-0832
P3006-1024
P3006-1420
P3007
P3008
P3009
P3010



P3016-0632
P3016-0832
P3016-1024
P3016-1420



P1012
P1023
P1024S

Channel Finishes: PL, GR, HG, PG, ZD; Standard Lengths: 10' & 20'

P3000 - BEAM LOADING

Span In	Max Allowable Uniform Load Lbs	Defl. at Uniform Load In	Uniform Loading at Deflection		
			Span/180 Lbs	Span/240 Lbs	Span/360 Lbs
24	1,280	0.07	1,280	1,280	1,280
36	850	0.15	850	850	580
48	640	0.26	640	490	330
60	510	0.41	420	310	210
72	430	0.59	290	220	150
84	370	0.81	210	160	110
96	320	1.05	160	120	80
108	280	1.30	130	100	60
120	260	1.66	100	80	50
144	210	2.32	70	50	40
168	180	3.15	50	40	30
192	160	4.18	40	30	NR
216	140	5.21	NR	NR	NR
240	130	6.64	NR	NR	NR

P3001 - BEAM LOADING

Span In	Max Allowable Uniform Load Lbs	Defl. at Uniform Load In	Uniform Loading at Deflection		
			Span/180 Lbs	Span/240 Lbs	Span/360 Lbs
24	2,960*	0.03	2,960*	2,960*	2,960*
36	2,400	0.08	2,400	2,400	2,400
48	1,800	0.15	1,800	1,800	1,610
60	1,440	0.23	1,440	1,440	1,030
72	1,200	0.33	1,200	1,080	720
84	1,030	0.46	1,030	790	530
96	900	0.59	810	610	400
108	800	0.75	640	480	320
120	720	0.93	520	390	260
144	600	1.34	360	270	180
168	510	1.81	260	200	130
192	450	2.38	200	150	100
216	400	3.01	160	120	80
240	360	3.72	130	100	NR

P3000 - COLUMN LOADING

Unbraced Height In	Maximum Allowable Load at Slot Face Lbs	Maximum Column Load Applied at C.G.			
		K = 0.65 Lbs	K = 0.80 Lbs	K = 1.0 Lbs	K = 1.2 Lbs
24	3,180	9,690	8,980	8,050	7,210
36	2,920	8,160	7,210	6,130	5,240
48	2,590	6,820	5,810	4,730	3,860
60	2,300	5,740	4,730	3,690	2,990
72	2,040	4,850	3,860	2,990	2,270
84	1,830	4,100	3,240	2,400	**
96	1,650	3,530	2,770	1,840	**
108	1,450	3,080	2,270	**	**
120	1,250	2,710	1,840	**	**

P3001 - COLUMN LOADING

Unbraced Height In	Maximum Allowable Load at Slot Face Lbs	Maximum Column Load Applied at C.G.			
		K = 0.65 Lbs	K = 0.80 Lbs	K = 1.0 Lbs	K = 1.2 Lbs
24	5,740	21,780	21,200	20,430	19,720
36	5,620	20,520	19,720	18,830	17,680
48	5,520	19,400	18,570	16,570	14,260
60	5,330	18,510	16,570	13,670	10,810
72	5,030	16,850	14,260	10,810	7,730
84	4,630	14,990	11,930	8,180	5,680
96	4,190	13,090	9,720	6,260	4,350
108	3,720	11,230	7,730	4,950	**
120	3,300	9,460	6,260	4,010	**
144	2,620	6,590	4,350	**	**

P3000/P3001 - ELEMENTS OF SECTION

Parameter	P3000		P3001	
Area of Section	0.500	In ²	1.000	In ²
Axis 1-1				
Moment of Inertia (I)	0.120	In ⁴	0.591	In ⁴
Section Modulus (S)	0.153	In ³	0.430	In ³
Radius of Gyration (r)	0.489	In	0.769	In
Axis 2-2				
Moment of Inertia (I)	0.203	In ⁴	0.407	In ⁴
Section Modulus (S)	0.250	In ³	0.501	In ³
Radius of Gyration (r)	0.638	In	0.638	In

Notes:

* Load limited by spot weld shear.

** KL/r > 200

NR = Not Recommended.

- Beam loads are given in total uniform load (W Lbs) not uniform load (w lbs/ft or w lbs/in).
- Beam loads are based on a simple span and assumed to be adequately laterally braced. Unbraced spans can reduce beam load carrying capacity. Refer to Page 62 for reduction factors for unbraced lengths.
- For pierced channel, multiply beam loads by the following factor:
"KO" Series95% **"T" Series85%**
"HS" Series90% **"SL" Series85%**
- Deduct channel weight from the beam loads.
- For concentrated midspan point loads, multiply beam loads by 50% and the corresponding deflection by 80%. For other load conditions refer to page 18.
- All beam loads are for bending about Axis 1-1.

1 5/8" Channel
Telestrut
Nuts & Hardware
General Fittings
Pipe/Conduit Supports
Electrical Fittings
Concrete Inserts
Solar
Unipier®



1 5/8" Channel

Telestrut

Nuts & Hardware

General Fittings

Pipe/Conduit Supports

Electrical Fittings

Concrete Inserts

Solar

Unipier®

P3000 - BEAM LOADING (METRIC)

Span mm	Max Allowable Uniform Load kN	Defl. at Uniform Load mm	Uniform Loading at Deflection		
			Span/180 kN	Span/240 kN	Span/360 kN
600	5.8	2	5.8	5.8	5.8
750	4.6	3	4.6	4.6	3.8
1,000	3.5	4	3.5	3.2	2.2
1,250	2.8	7	2.8	2.1	1.4
1,500	2.3	10	1.9	1.4	1.0
1,750	2.0	14	1.4	1.1	0.7
2,000	1.7	18	1.1	0.8	0.5
2,500	1.4	28	0.7	0.5	0.4
3,000	1.2	40	0.5	0.4	0.2
3,500	1.0	54	0.4	0.3	0.2
4,000	0.9	73	0.3	0.2	0.1
4,500	0.8	89	0.2	0.2	NR
5,000	0.7	115	0.2	0.1	NR
6,000	0.6	161	NR	NR	NR

P3001 - BEAM LOADING (METRIC)

Span mm	Max Allowable Uniform Load kN	Defl. at Uniform Load mm	Uniform Loading at Deflection		
			Span/180 kN	Span/240 kN	Span/360 kN
600	13.2 *	1	13.2 *	13.2 *	13.2 *
750	13.0	1	13.0	13.0	13.0
1,000	9.8	3	9.8	9.8	9.8
1,250	7.8	4	7.8	7.8	6.9
1,500	6.5	6	6.5	6.5	4.8
1,750	5.6	8	5.6	5.2	3.5
2,000	4.9	10	4.9	4.0	2.7
2,500	3.9	16	3.4	2.6	1.7
3,000	3.2	23	2.4	1.8	1.2
3,500	2.8	31	1.7	1.3	0.9
4,000	2.4	41	1.3	1.0	0.7
4,500	2.2	52	1.1	0.8	0.5
5,000	2.0	64	0.8	0.6	0.4
6,000	1.6	92	0.6	0.4	0.3

P3000 - COLUMN LOADING (METRIC)

Unbraced Height mm	Maximum Allowable Load at Slot Face kN	Maximum Column Load Applied at C.G.			
		K = 0.65 kN	K = 0.80 kN	K = 1.0 kN	K = 1.2 kN
600	14.2	43.3	40.2	36.1	32.4
750	13.6	39.9	36.1	31.5	27.6
1,000	12.5	34.5	30.2	25.3	21.3
1,250	11.4	29.8	25.3	20.5	16.7
1,500	10.3	25.8	21.3	16.7	13.6
1,750	9.4	22.5	18.1	14.0	11.0
2,000	8.5	19.6	15.5	11.9	8.5
2,250	7.8	17.2	13.6	9.6	**
2,500	7.2	15.3	11.9	**	**
2,750	6.4	13.7	10.1	**	**

P3001 - COLUMN LOADING (METRIC)

Unbraced Height mm	Maximum Allowable Load at Slot Face kN	Maximum Column Load Applied at C.G.			
		K = 0.65 kN	K = 0.80 kN	K = 1.0 kN	K = 1.2 kN
600	25.5	97.1	94.5	91.1	88.0
750	25.3	94.3	91.1	87.3	84.0
1,000	24.9	89.8	86.1	82.2	74.5
1,250	24.6	85.8	82.2	72.4	61.8
1,500	23.8	82.6	74.5	61.8	49.2
1,750	22.8	77.0	66.1	51.3	37.5
2,000	21.4	70.3	57.6	41.3	28.7
2,250	19.9	63.4	49.2	32.7	22.7
2,500	18.2	56.5	41.3	26.5	18.4
2,750	16.5	49.8	34.2	21.9	**

P3000/P3001 - ELEMENTS OF SECTION (METRIC)

Parameter	P3000		P3001	
Area of Section	3.23	cm ²	6.45	cm ²
Axis 1-1				
Moment of Inertia (I)	4.97	cm ⁴	24.61	cm ⁴
Section Modulus (S)	2.51	cm ³	7.05	cm ³
Radius of Gyration (r)	1.24	cm	1.95	cm
Axis 2-2				
Moment of Inertia (I)	8.47	cm ⁴	16.93	cm ⁴
Section Modulus (S)	4.10	cm ³	8.20	cm ³
Radius of Gyration (r)	1.62	cm	1.62	cm

Notes:

* Load limited by spot weld shear.

** KL/r > 200

NR = Not Recommended.

- Beam loads are given in total uniform load (W Lbs) not uniform load (w lbs/ft or w lbs/in).
- Beam loads are based on a simple span and assumed to be adequately laterally braced. Unbraced spans can reduce beam load carrying capacity. Refer to Page 62 for reduction factors for unbraced lengths.
- For pierced channel, multiply beam loads by the following factor:

"KO" Series	95%	"T" Series	85%
"HS" Series	90%	"SL" Series	85%
- Deduct channel weight from the beam loads.
- For concentrated midspan point loads, multiply beam loads by 50% and the corresponding deflection by 80%. For other load conditions refer to page 18.
- All beam loads are for bending about Axis 1-1.

P3300

GR PG PL

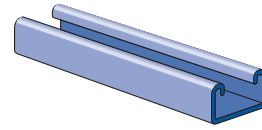
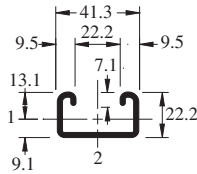
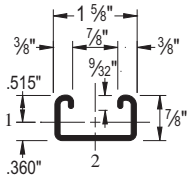

Wt/100 Ft: 134 Lbs (200 kg/100 m)
 Allowable Moment 1,800 In-Lbs (200 N•m)
 12 Gauge Nominal Thickness .105" (2.7mm)

P3301

GR PG

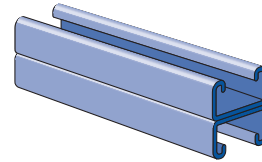
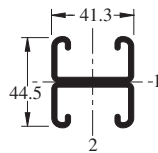
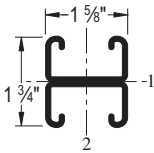

Wt/100 Ft: 269 Lbs (400 kg/100 m)
 Allowable Moment 5,060 In-Lbs (570 N•m)
 12 Gauge Nominal Thickness .105" (2.7mm)

P3300 HS

GR PG

9/16" (14.3) Dia. Holes
 1 7/8" (47.6) on Center

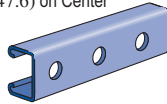

Wt/100 Ft: 130 Lbs (193 kg/100 m)

P3300 T

GR PG

Slots are
 1 1/8" (28.6) x 9/16" (14.3)
 2" (50.8) on Center

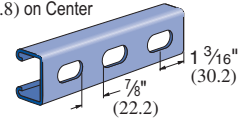

Wt/100 Ft: 130 Lbs (193 kg/100 m)

P3300 SL

GR PG

Slots are
 3" (76.2) x 1 3/32" (10.3)
 4" (101.6) on Center

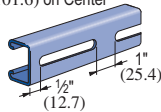

Wt/100 Ft: 130 Lbs (193 kg/100 m)

CHANNEL NUTS (REFER TO PAGES 73,74 FOR DETAILS)

SEE PAGE 73, 74



P4006-0832
 P4006-1024
 P4006-1420
 P4007
 P4008
 P4009
 P4010



P4006T1420
 P4008T
 P4010T



P4012
 P4023



P3006-0832
 P3006-1024
 P3006-1420
 P3007
 P3008
 P3009
 P3013



P3016-0632
 P3016-0832
 P3016-1024
 P3016-1420

Channel Finishes: PL, GR, HG, PG, ZD; Standard Lengths: 10' & 20'

P3300 - BEAM LOADING

Span In	Max Allowable Uniform Load Lbs	Defl. at Uniform Load In	Uniform Loading at Deflection		
			Span/180 Lbs	Span/240 Lbs	Span/360 Lbs
24	600	0.10	600	600	400
36	400	0.22	360	270	180
48	300	0.40	200	150	100
60	240	0.62	130	100	60
72	200	0.89	90	70	40
84	170	1.20	70	50	30
96	150	1.59	50	40	30
108	130	1.96	40	30	20
120	120	2.48	30	20	20

P3301 - BEAM LOADING

Span In	Max Allowable Uniform Load Lbs	Defl. at Uniform Load In	Uniform Loading at Deflection		
			Span/180 Lbs	Span/240 Lbs	Span/360 Lbs
24	1,690	0.06	1,690	1,690	1,690
36	1,130	0.13	1,130	1,130	860
48	840	0.23	840	720	480
60	680	0.37	620	460	310
72	560	0.52	430	320	210
84	480	0.71	310	240	160
96	420	0.93	240	180	120
108	380	1.20	190	140	100
120	340	1.47	150	120	80
144	280	2.09	110	80	50

P3300 - COLUMN LOADING

Unbraced Height In	Maximum Allowable Load at Slot Face Lbs	Maximum Column Load Applied at C.G.			
		K = 0.65 Lbs	K = 0.80 Lbs	K = 1.0 Lbs	K = 1.2 Lbs
24	2,360	7,740	7,260	6,350	5,390
36	2,120	6,470	5,390	3,990	2,810
48	1,760	4,910	3,550	2,270	1,580
60	1,380	3,440	2,270	1,460	**
72	1,080	2,390	1,580	**	**

P3301 - COLUMN LOADING

Unbraced Height In	Maximum Allowable Load at Slot Face Lbs	Maximum Column Load Applied at C.G.			
		K = 0.65 Lbs	K = 0.80 Lbs	K = 1.0 Lbs	K = 1.2 Lbs
24	4,290	16,990	16,580	15,770	14,720
36	4,150	15,890	14,720	12,980	11,120
48	3,940	14,160	12,360	9,880	7,510
60	3,650	12,210	9,880	6,940	4,820
72	3,270	10,190	7,510	4,820	3,350
84	2,800	8,220	5,530	3,540	**
96	2,410	6,420	4,240	**	**
108	2,080	5,070	3,350	**	**

P3300/P3301 - ELEMENTS OF SECTION

Parameter	P3300		P3301	
	Value	Unit	Value	Unit
Area of Section	0.395	In ²	0.790	In ²
Axis 1-1				
Moment of Inertia (I)	0.037	In ⁴	0.176	In ⁴
Section Modulus (S)	0.072	In ³	0.201	In ³
Radius of Gyration (r)	0.306	In	0.472	In
Axis 2-2				
Moment of Inertia (I)	0.143	In ⁴	0.285	In ⁴
Section Modulus (S)	0.176	In ³	0.351	In ³
Radius of Gyration (r)	0.601	In	0.601	In

Notes:

* Load limited by spot weld shear.

** KL/r > 200

NR = Not Recommended.

- Beam loads are given in total uniform load (W Lbs) not uniform load (w lbs/ft or w lbs/in).
- Beam loads are based on a simple span and assumed to be adequately laterally braced. Unbraced spans can reduce beam load carrying capacity. Refer to Page 62 for reduction factors for unbraced lengths.
- For pierced channel, multiply beam loads by the following factor:

"KO" Series	95%	"T" Series	85%
"HS" Series	90%	"SL" Series	85%
- Deduct channel weight from the beam loads.
- For concentrated midspan point loads, multiply beam loads by 50% and the corresponding deflection by 80%. For other load conditions refer to page 18.
- All beam loads are for bending about Axis 1-1.

P3300 - BEAM LOADING (METRIC)

Span mm	Max Allowable Uniform Load kN	Defl. at Uniform Load mm	Uniform Loading at Deflection		
			Span/180 kN	Span/240 kN	Span/360 kN
600	2.7	2	2.7	2.7	1.9
750	2.2	4	2.2	1.8	1.2
1,000	1.6	7	1.3	1.0	0.7
1,250	1.3	10	0.8	0.6	0.4
1,500	1.1	15	0.6	0.4	0.3
1,750	0.9	21	0.4	0.3	0.2
2,000	0.8	27	0.3	0.3	0.2
2,500	0.7	43	0.2	0.2	0.1
3,000	0.5	60	0.1	0.1	0.1
3,500	0.4	79	0.1	0.1	NR

P3301 - BEAM LOADING (METRIC)

Span mm	Max Allowable Uniform Load kN	Defl. at Uniform Load mm	Uniform Loading at Deflection		
			Span/180 kN	Span/240 kN	Span/360 kN
600	7.6	1	7.6	7.6	7.6
750	6.1	2	6.1	6.1	5.6
1,000	4.6	4	4.6	4.6	3.2
1,250	3.6	6	3.6	3.1	2.0
1,500	3.1	9	2.8	2.1	1.4
1,750	2.6	12	2.1	1.6	1.0
2,000	2.3	16	1.6	1.2	0.8
2,500	1.8	25	1.0	0.8	0.5
3,000	1.5	36	0.7	0.5	0.4
3,500	1.3	48	0.5	0.4	0.3
4,000	1.2	65	0.4	0.3	0.2

P3300 - COLUMN LOADING (METRIC)

Unbraced Height mm	Maximum Allowable Load at Slot Face kN	Maximum Column Load Applied at C.G.			
		K = 0.65 kN	K = 0.80 kN	K = 1.0 kN	K = 1.2 kN
600	10.5	34.6	32.6	28.6	24.4
750	10.1	32.3	28.6	23.3	18.2
1,000	9.1	26.9	21.6	15.0	10.5
1,250	7.6	21.2	15.0	9.6	6.7
1,500	6.3	15.8	10.5	6.7	**
1,750	5.1	11.6	7.6	**	**

P3301 - COLUMN LOADING (METRIC)

Unbraced Height mm	Maximum Allowable Load at Slot Face kN	Maximum Column Load Applied at C.G.			
		K = 0.65 kN	K = 0.80 kN	K = 1.0 kN	K = 1.2 kg
600	19.1	75.7	73.9	70.5	66.0
750	18.9	73.8	70.5	64.7	58.4
1,000	18.2	68.6	62.7	53.9	44.8
1,250	17.4	62.1	53.9	42.6	31.9
1,500	16.4	55.0	44.8	31.9	22.2
1,750	15.0	47.6	36.0	23.4	16.3
2,000	13.3	40.3	28.0	17.9	**
2,250	11.8	33.4	22.2	14.1	**
2,500	10.4	27.2	17.9	**	**
2,750	9.2	22.5	14.8	**	**

P3300/P3301 - ELEMENTS OF SECTION (METRIC)

Parameter	P3300	P3301
Area of Section	2.55 cm ²	5.10 cm ²
Axis 1-1		
Moment of Inertia (I)	1.54 cm ⁴	7.33 cm ⁴
Section Modulus (S)	1.18 cm ³	3.30 cm ³
Radius of Gyration (r)	0.78 cm	1.20 cm
Axis 2-2		
Moment of Inertia (I)	5.94 cm ⁴	11.87 cm ⁴
Section Modulus (S)	2.88 cm ³	5.75 cm ³
Radius of Gyration (r)	1.53 cm	1.53 cm

Notes:

* Load limited by spot weld shear.

** KL/r > 200

NR = Not Recommended.

- Beam loads are given in total uniform load (W Lbs) not uniform load (w lbs/ft or w lbs/in).
- Beam loads are based on a simple span and assumed to be adequately laterally braced. Unbraced spans can reduce beam load carrying capacity. Refer to Page 62 for reduction factors for unbraced lengths.
- For pierced channel, multiply beam loads by the following factor:

"KO" Series	95%	"T" Series	85%
"HS" Series	90%	"SL" Series	85%
- Deduct channel weight from the beam loads.
- For concentrated midspan point loads, multiply beam loads by 50% and the corresponding deflection by 80%. For other load conditions refer to page 18.
- All beam loads are for bending about Axis 1-1.



1 5/8" Channel
Telestrut
Nuts & Hardware
General Fittings
Pipe/Conduit Supports
Electrical Fittings
Concrete Inserts
Solar

P4000

HG PG GR

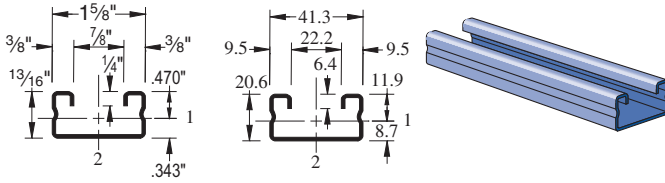

Wt/100 Ft: 83 Lbs (123 kg/100 m)
Allowable Moment 1,230 In-Lbs (140 N•m)
16 Gauge Nominal Thickness .060" (1.5mm)

P4001

GR PG

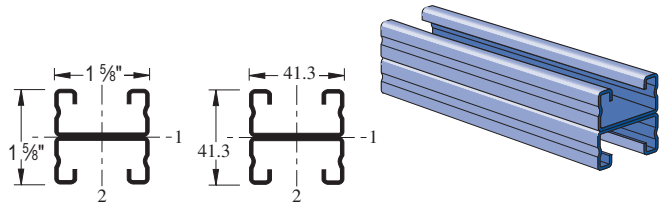

Wt/100 Ft: 166 Lbs (246 kg/100 m)
Allowable Moment 3,210 In-Lbs (360 N•m)
16 Gauge Nominal Thickness .060" (1.5mm)

P4003

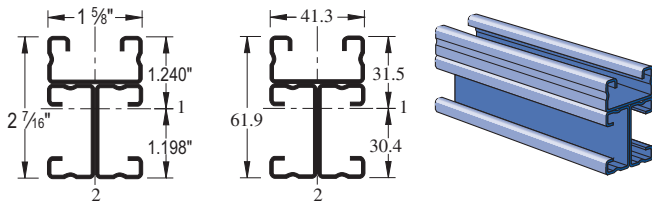

Wt/100 Ft: 248 Lbs (370 kg/100 m)
Allowable Moment 8,600 In-Lbs (970 N•m)
16 Gauge Nominal Thickness .060" (1.5mm)

P4004

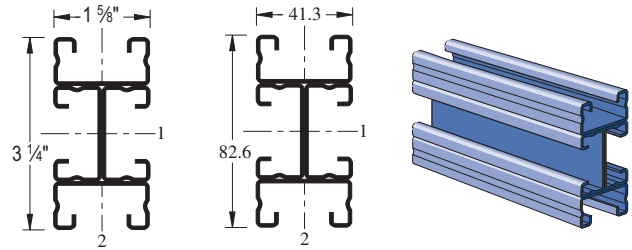

Wt/100 Ft: 331 Lbs (493 kg/100 m)
Allowable Moment 13,650 In-Lbs (1,540 N•m)
16 Gauge Nominal Thickness .060" (1.5mm)

P4000 HS

GR PG

9/16" (14.3) Dia. Holes
1 7/8" (47.6) on Center

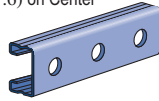

Wt/100 Ft: 79 Lbs (118 kg/100 m)

P4000 T

GR PG

Slots are
1 1/8" (28.6) x 9/16" (14.3)
2" (50.8) on Center

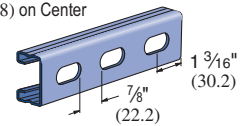

Wt/100 Ft: 79 Lbs (118 kg/100 m)

P4000 SL

GR PG

Slots are
3" (76.2) x 1 3/32" (10.3)
4" (101.6) on Center

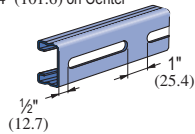

Wt/100 Ft: 79 Lbs (118 kg/100 m)

CHANNEL NUTS (REFER TO PAGES 73,74 FOR DETAILS)

SEE PAGE 73, 74



P4006-0832
P4006-1024
P4006-1420
P4007
P4008
P4009
P4010



P4006T1420
P4008T
P4010T



P4012
P4023



P3006-0832
P3006-1024
P3006-1420
P3007
P3008
P3009
P3013



P3016-0632
P3016-0832
P3016-1024
P3016-1420

Channel Finishes: PL, GR, HG, PG, ZD; Standard Lengths: 10' & 20'

P4000 - BEAM LOADING

Span In	Max Allowable Uniform Load Lbs	Defl. at Uniform Load In	Uniform Loading at Deflection		
			Span/180 Lbs	Span/240 Lbs	Span/360 Lbs
24	410	0.11	410	370	250
36	270	0.24	220	170	110
48	200	0.43	120	90	60
60	160	0.67	80	60	40
72	140	1.01	60	40	30
84	120	1.38	40	30	20
96	100	1.72	30	20	20
108	90	2.20	20	20	10
120	80	2.68	20	10	10

P4001 - BEAM LOADING

Span In	Max Allowable Uniform Load Lbs	Defl. at Uniform Load In	Uniform Loading at Deflection		
			Span/180 Lbs	Span/240 Lbs	Span/360 Lbs
24	810*	0.05	810*	810*	810*
36	710	0.14	710	710	500
48	540	0.25	540	430	280
60	430	0.40	360	270	180
72	360	0.57	250	190	130
84	310	0.78	190	140	90
96	270	1.02	140	110	70
108	240	1.29	110	80	60
120	210	1.54	90	70	50
144	180	2.29	60	50	30

P4000 - COLUMN LOADING

Unbraced Height In	Maximum Allowable Load at Slot Face Lbs	Maximum Column Load Applied at C.G.			
		K = 0.65 Lbs	K = 0.80 Lbs	K = 1.0 Lbs	K = 1.2 Lbs
24	1,630	4,670	4,290	3,780	3,310
36	1,450	3,840	3,310	2,460	1,730
48	1,160	3,030	2,190	1,400	970
60	870	2,120	1,400	900	**
72	670	1,470	970	**	**

P4001 - COLUMN LOADING

Unbraced Height In	Maximum Allowable Load at Slot Face Lbs	Maximum Column Load Applied at C.G.			
		K = 0.65 Lbs	K = 0.80 Lbs	K = 1.0 Lbs	K = 1.2 Lbs
24	2,830	10,390	10,000	9,470	8,960
36	2,740	9,530	8,960	7,870	6,700
48	2,590	8,620	7,480	5,910	4,440
60	2,340	7,380	5,910	4,090	2,840
72	2,020	6,110	4,440	2,840	1,970
84	1,700	4,880	3,260	2,090	**
96	1,440	3,780	2,500	**	**
108	1,230	2,990	1,970	**	**

P4000/P4001 - ELEMENTS OF SECTION

Parameter	P4000		P4001	
Area of Section	0.244	In ²	0.487	In ²
Axis 1-1				
Moment of Inertia (I)	0.023	In ⁴	0.104	In ⁴
Section Modulus (S)	0.049	In ³	0.128	In ³
Radius of Gyration (r)	0.306	In	0.462	In
Axis 2-2				
Moment of Inertia (I)	0.092	In ⁴	0.183	In ⁴
Section Modulus (S)	0.113	In ³	0.225	In ³
Radius of Gyration (r)	0.613	In	0.613	In

Notes:

* Load limited by spot weld shear.

** KL/r > 200

NR = Not Recommended.

- Beam loads are given in total uniform load (W Lbs) not uniform load (w lbs/ft or w lbs/in).
- Beam loads are based on a simple span and assumed to be adequately laterally braced. Unbraced spans can reduce beam load carrying capacity. Refer to Page 62 for reduction factors for unbraced lengths.
- For pierced channel, multiply beam loads by the following factor:

"KO" Series	95%	"T" Series	85%
"HS" Series	90%	"SL" Series	85%
- Deduct channel weight from the beam loads.
- For concentrated midspan point loads, multiply beam loads by 50% and the corresponding deflection by 80%. For other load conditions refer to page 18.
- All beam loads are for bending about Axis 1-1.

P4000 - BEAM LOADING (METRIC)

Span mm	Max Allowable Uniform Load kN	Defl. at Uniform Load mm	Uniform Loading at Deflection		
			Span/180 kN	Span/240 kN	Span/360 kN
600	1.9	3	1.9	1.7	1.2
750	1.5	4	1.5	1.1	0.7
1,000	1.1	8	0.8	0.6	0.4
1,250	0.9	12	0.5	0.4	0.3
1,500	0.8	17	0.4	0.3	0.2
1,750	0.6	23	0.3	0.2	0.1
2,000	0.5	29	0.2	0.1	0.1
2,500	0.4	47	0.1	0.1	NR
3,000	0.4	65	0.1	0.1	NR

P4001 - BEAM LOADING (METRIC)

Span mm	Max Allowable Uniform Load kN	Defl. at Uniform Load mm	Uniform Loading at Deflection		
			Span/180 kN	Span/240 kN	Span/360 kN
600	3.6 *	1	3.6 *	3.6 *	3.6 *
750	3.6 *	2	3.6 *	3.6 *	3.3
1,000	2.9	4	2.9	2.8	1.9
1,250	2.3	7	2.3	1.8	1.2
1,500	2.0	10	1.6	1.2	0.8
1,750	1.6	13	1.2	0.9	0.6
2,000	1.5	17	0.9	0.7	0.5
2,500	1.2	27	0.6	0.4	0.3
3,000	1.0	39	0.4	0.3	0.2
3,500	0.8	54	0.3	0.2	0.1

P4000 - COLUMN LOADING (METRIC)

Unbraced Height mm	Maximum Allowable Load at Slot Face kN	Maximum Column Load Applied at C.G.			
		K = 0.65 kN	K = 0.80 kN	K = 1.0 kN	K = 1.2 kN
600	7.2	20.9	19.2	17.0	14.9
750	6.9	19.1	17.0	14.4	11.3
1,000	6.1	16.1	13.3	9.2	6.5
1,250	5.0	13.0	9.2	5.9	4.1
1,500	4.0	9.7	6.5	4.1	**
1,750	3.2	7.2	4.7	**	**

P4001 - COLUMN LOADING (METRIC)

Unbraced Height mm	Maximum Allowable Load at Slot Face kN	Maximum Column Load Applied at C.G.			
		K = 0.65 kN	K = 0.80 kN	K = 1.0 kN	K = 1.2 kN
600	12.6	46.3	44.6	42.3	40.0
750	12.4	44.5	42.3	39.5	35.4
1,000	12.1	41.3	38.2	32.6	26.9
1,250	11.4	37.8	32.6	25.4	18.8
1,500	10.5	33.3	26.9	18.8	13.0
1,750	9.4	28.6	21.3	13.8	9.6
2,000	8.1	24.1	16.5	10.5	**
2,250	7.1	19.8	13.0	8.4	**
2,500	6.2	16.0	10.5	**	**
2,750	5.4	13.2	8.7	**	**

P4000/P4001 - ELEMENTS OF SECTION (METRIC)

Parameter	P4000		P4001	
Area of Section	1.57	cm ²	3.14	cm ²
Axis 1-1				
Moment of Inertia (I)	0.95	cm ⁴	4.32	cm ⁴
Section Modulus (S)	0.80	cm ³	2.09	cm ³
Radius of Gyration (r)	0.78	cm	1.17	cm
Axis 2-2				
Moment of Inertia (I)	3.81	cm ⁴	7.62	cm ⁴
Section Modulus (S)	1.85	cm ³	3.69	cm ³
Radius of Gyration (r)	1.56	cm	1.56	cm

Notes:

* Load limited by spot weld shear.

** KL/r > 200

NR = Not Recommended.

- Beam loads are given in total uniform load (W Lbs) not uniform load (w lbs/ft or w lbs/in).
- Beam loads are based on a simple span and assumed to be adequately laterally braced. Unbraced spans can reduce beam load carrying capacity. Refer to Page 62 for reduction factors for unbraced lengths.
- For pierced channel, multiply beam loads by the following factor:

"KO" Series	95%	"T" Series	85%
"HS" Series	90%	"SL" Series	85%
- Deduct channel weight from the beam loads.
- For concentrated midspan point loads, multiply beam loads by 50% and the corresponding deflection by 80%. For other load conditions refer to page 18.
- All beam loads are for bending about Axis 1-1.

P4100

GR PG

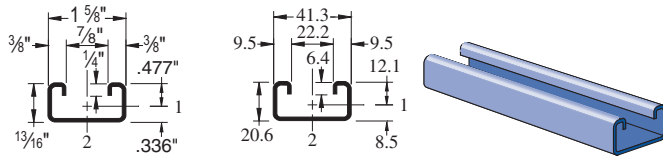

Wt/100 Ft: 98 Lbs (147 kg/100 m)
 Allowable Moment 1,360 In-Lbs (150 N•m)
 14 Gauge Nominal Thickness .075" (1.9mm)

P4101

GR PG

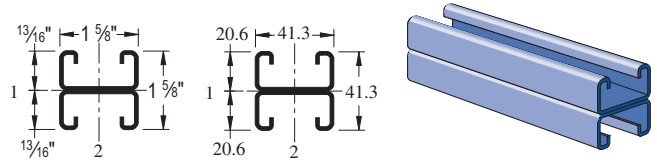

Wt/100 Ft: 197 Lbs (293 kg/100 m)
 Allowable Moment 3,610 In-Lbs (410 N•m)
 14 Gauge Nominal Thickness .075" (1.9mm)

P4100 HS

GR PG

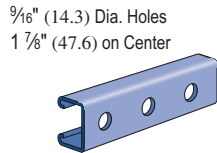

Wt/100 Ft: 87 Lbs (129 kg/100 m)

P4100 T

GR PG

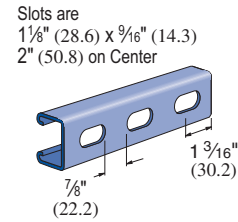

Wt/100 Ft: 87 Lbs (129 kg/100 m)

P4100 SL

GR PG

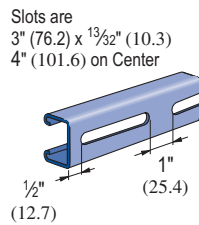

Wt/100 Ft: 87 Lbs (129 kg/100 m)

P4101 T

GR PG

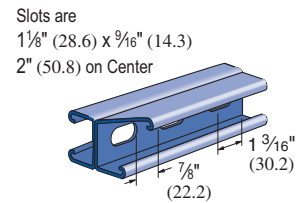

Wt/100 Ft: 174 Lbs (259 kg/100 m)

CHANNEL NUTS (REFER TO PAGES 73,74 FOR DETAILS)

SEE PAGE 73, 74



P4006-0832
P4006-1024
P4006-1420
P4007
P4008
P4009
P4010



P4006T1420
P4008T
P4010T



P4012
P4023



P3006-0832
P3006-1024
P3006-1420
P3007
P3008
P3009
P3013



P3016-0632
P3016-0832
P3016-1024
P3016-1420

Channel Finishes: PL, GR, HG, PG, ZD; Standard Lengths: 10' & 20'



1 5/8" Channel

Telestrut

Nuts & Hardware

General Fittings

Pipe/Conduit Supports

Electrical Fittings

Concrete Inserts

Solar

Unipier®

P4100 - BEAM LOADING

Span In	Max Allowable Uniform Load Lbs	Defl. at Uniform Load In	Uniform Loading at Deflection		
			Span/180 Lbs	Span/240 Lbs	Span/360 Lbs
24	450	0.11	450	420	280
36	300	0.24	250	190	130
48	230	0.44	140	110	70
60	180	0.67	90	70	50
72	150	0.96	60	50	30
84	130	1.32	50	30	20
96	110	1.67	40	30	20
108	100	2.16	30	20	10
120	90	2.67	20	20	10
144	80	4.09	20	NR	NR
168	60	4.88	NR	NR	NR
192	60	7.28	NR	NR	NR
216	50	8.64	NR	NR	NR
240	50	11.85	NR	NR	NR

P4101 - BEAM LOADING

Span In	Max Allowable Uniform Load Lbs	Defl. at Uniform Load In	Uniform Loading at Deflection		
			Span/180 Lbs	Span/240 Lbs	Span/360 Lbs
24	1,090*	0.06	1,090*	1,090*	1,090*
36	800	0.14	800	800	570
48	600	0.25	600	480	320
60	480	0.39	410	310	200
72	400	0.57	280	210	140
84	340	0.76	210	160	100
96	300	1.00	160	120	80
108	270	1.29	130	90	60
120	240	1.57	100	80	50
144	200	2.26	70	50	40
168	170	3.05	50	40	30
192	150	4.02	40	NR	NR
216	130	4.96	NR	NR	NR
240	120	6.28	NR	NR	NR

P4100 - COLUMN LOADING

Unbraced Height In	Maximum Allowable Load at Slot Face Lbs	Maximum Column Load Applied at C.G.			
		K = 0.65 Lbs	K = 0.80 Lbs	K = 1.0 Lbs	K = 1.2 Lbs
24	1,840	5,610	5,210	4,570	3,850
36	1,640	4,660	3,850	2,800	1,960
48	1,310	3,490	2,480	1,590	1,100
60	1,000	2,400	1,590	**	**
72	770	1,670	1,100	**	**

P4101 - COLUMN LOADING

Unbraced Height In	Maximum Allowable Load at Slot Face Lbs	Maximum Column Load Applied at C.G.			
		K = 0.65 Lbs	K = 0.80 Lbs	K = 1.0 Lbs	K = 1.2 Lbs
24	3,240	12,370	11,950	11,370	10,540
36	3,120	11,470	10,540	9,160	7,720
48	2,940	10,090	8,680	6,770	4,980
60	2,680	8,560	6,770	4,590	3,190
72	2,310	7,010	4,980	3,190	2,220
84	1,950	5,530	3,660	2,340	**
96	1,650	4,250	2,800	**	**
108	1,410	3,360	2,220	**	**

P4100/P4101 - ELEMENTS OF SECTION

Parameter	P4100		P4101	
Area of Section	0.290	In ²	0.579	In ²
Axis 1-1				
Moment of Inertia (I)	0.026	In ⁴	0.117	In ⁴
Section Modulus (S)	0.054	In ³	0.143	In ³
Radius of Gyration (r)	0.298	In	0.449	In
Axis 2-2				
Moment of Inertia (I)	0.107	In ⁴	0.214	In ⁴
Section Modulus (S)	0.132	In ³	0.264	In ³
Radius of Gyration (r)	0.609	In	0.608	In

Notes:

* Load limited by spot weld shear.

** KL/r > 200

NR = Not Recommended.

- Beam loads are given in total uniform load (W Lbs) not uniform load (w lbs/ft or w lbs/in).
- Beam loads are based on a simple span and assumed to be adequately laterally braced. Unbraced spans can reduce beam load carrying capacity. Refer to Page 62 for reduction factors for unbraced lengths.
- For pierced channel, multiply beam loads by the following factor:

"KO" Series	95%	"T" Series	85%
"HS" Series	90%	"SL" Series	85%
- Deduct channel weight from the beam loads.
- For concentrated midspan point loads, multiply beam loads by 50% and the corresponding deflection by 80%. For other load conditions refer to page 18.
- All beam loads are for bending about Axis 1-1.

P4100 - BEAM LOADING (METRIC)

Span mm	Max Allowable Uniform Load kN	Defl. at Uniform Load mm	Uniform Loading at Deflection		
			Span/180 kN	Span/240 kN	Span/360 kN
600	2.0	3	2.0	2.0	1.3
750	1.6	4	1.6	1.2	0.8
1,000	1.2	7	0.9	0.7	0.4
1,250	1.0	11	0.6	0.4	0.3
1,500	0.8	16	0.4	0.3	0.2
1,750	0.7	23	0.3	0.2	0.1
2,000	0.6	30	0.2	0.2	0.1
2,500	0.5	46	0.1	0.1	0.1
3,000	0.4	65	0.1	0.1	NR

P4101 - BEAM LOADING (METRIC)

Span mm	Max Allowable Uniform Load kN	Defl. at Uniform Load mm	Uniform Loading at Deflection		
			Span/180 kN	Span/240 kN	Span/360 kN
600	4.8 *	1	4.8 *	4.8 *	4.8 *
750	4.4	2	4.4	4.4	3.7
1,000	3.2	4	3.2	3.2	2.1
1,250	2.6	7	2.6	2.0	1.3
1,500	2.2	10	1.9	1.4	0.9
1,750	1.9	13	1.4	1.0	0.7
2,000	1.6	17	1.1	0.8	0.5
2,500	1.3	27	0.7	0.5	0.4
3,000	1.1	38	0.5	0.4	0.2
3,500	0.9	53	0.4	0.3	0.2

P4100 - COLUMN LOADING (METRIC)

Unbraced Height mm	Maximum Allowable Load at Slot Face kN	Maximum Column Load Applied at C.G.			
		K = 0.65 kN	K = 0.80 kN	K = 1.0 kN	K = 1.2 kN
600	8.2	25.1	23.3	20.6	17.4
750	7.8	23.2	20.6	16.6	12.8
1,000	6.9	19.3	15.3	10.5	7.3
1,250	5.6	15.0	10.5	6.7	4.7
1,500	4.5	11.0	7.3	4.7	**
1,750	3.6	8.1	5.3	**	**

P4101 - COLUMN LOADING (METRIC)

Unbraced Height mm	Maximum Allowable Load at Slot Face kN	Maximum Column Load Applied at C.G.			
		K = 0.65 kN	K = 0.80 kN	K = 1.0 kN	K = 1.2 kN
600	14.4	55.1	53.3	50.8	47.2
750	14.2	53.2	50.8	46.3	41.2
1,000	13.7	49.4	44.7	37.8	30.8
1,250	13.0	44.2	37.8	29.1	21.1
1,500	12.0	38.7	30.8	21.1	14.6
1,750	10.7	33.0	24.2	15.5	10.8
2,000	9.3	27.4	18.5	11.9	**
2,250	8.1	22.2	14.6	9.4	**

P4100/P4101 - ELEMENTS OF SECTION (METRIC)

Parameter	P4100	P4101
Area of Section	1.87 cm ²	3.74 cm ²
Axis 1-1		
Moment of Inertia (I)	1.07 cm ⁴	4.85 cm ⁴
Section Modulus (S)	0.88 cm ³	2.35 cm ³
Radius of Gyration (r)	0.76 cm	1.14 cm
Axis 2-2		
Moment of Inertia (I)	4.46 cm ⁴	8.93 cm ⁴
Section Modulus (S)	2.16 cm ³	4.32 cm ³
Radius of Gyration (r)	1.55 cm	1.55 cm

Notes:

* Load limited by spot weld shear.

** KL/r > 200

NR = Not Recommended.

- Beam loads are given in total uniform load (W Lbs) not uniform load (w lbs/ft or w lbs/in).
- Beam loads are based on a simple span and assumed to be adequately laterally braced. Unbraced spans can reduce beam load carrying capacity. Refer to Page 62 for reduction factors for unbraced lengths.
- For pierced channel, multiply beam loads by the following factor:

"KO" Series	95%	"T" Series	85%
"HS" Series	90%	"SL" Series	85%
- Deduct channel weight from the beam loads.
- For concentrated midspan point loads, multiply beam loads by 50% and the corresponding deflection by 80%. For other load conditions refer to page 18.
- All beam loads are for bending about Axis 1-1.



1 5/8" Channel

Telestrut

Nuts & Hardware

General Fittings

Pipe/Conduit Supports

Electrical Fittings

Concrete Inserts

Solar

Unipier®

P4400

GR PG

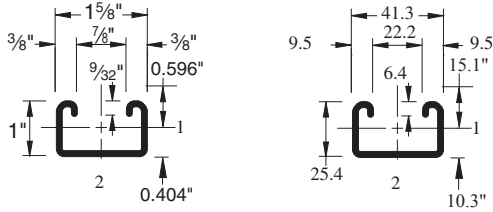
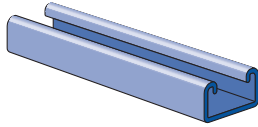

Wt/100 Ft: 144 Lbs (210 kg/100 m)
 Allowable Moment 2,300 In-Lbs (260 N•m)
 12 Gauge Nominal Thickness .105" (2.7mm)

P4401

GR PG

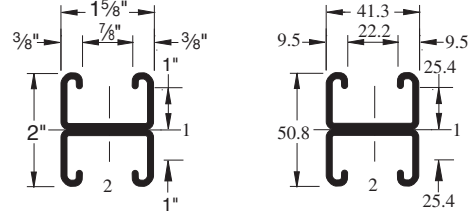
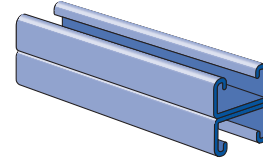

Wt/100 Ft: 289 Lbs (430 kg/100 m)
 Allowable Moment 6,410 In-Lbs (725 N•m)
 12 Gauge Nominal Thickness .105" (2.7mm)

P4400 HS

GR PG

9/16" (14.3) Dia. Holes
 1 7/8" (47.6) on Center

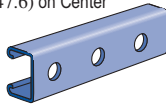

Wt/100 Ft: 136 Lbs (201 kg/100 m)

P4400 T

GR PG

Slots are
 1 1/8" (28.6) x 9/16" (14.3)
 2" (50.8) on Center

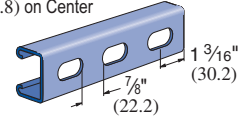

Wt/100 Ft: 136 Lbs (201 kg/100 m)

P4400 SL

GR PG

Slots are
 3" (76.2) x 1 3/32" (10.3)
 4" (101.6) on Center

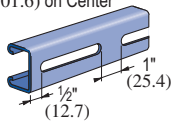

Wt/100 Ft: 136 Lbs (201 kg/100 m)

CHANNEL NUTS (REFER TO PAGES 73,74 FOR DETAILS)

SEE PAGE 73, 74



P4006-0832
P4006-1024
P4006-1420
P4007
P4008
P4009
P4010



P4006T-1420
P4008T
P4010T



P4012
P4023



P3006-0832
P3006-1024
P3006-1420
P3007
P3008
P3009
P3013



P3016-0632
P3016-0832
P3016-1024
P3016-1420

Channel Finishes: PL, GR, HG, PG, ZD; Standard Lengths: 10' & 20'

P4400 - BEAM LOADING

Span In	Max Allowable Uniform Load Lbs	Defl. at Uniform Load In	Uniform Loading at Deflection		
			Span/180 Lbs	Span/240 Lbs	Span/360 Lbs
24	770	0.09	770	770	580
36	510	0.20	510	390	260
48	380	0.35	290	220	150
60	310	0.56	190	140	90
72	260	0.80	130	100	60
84	220	1.08	90	70	50
96	190	1.39	70	50	40
108	170	1.78	60	40	30
120	150	2.15	50	30	20
144	130	3.22	30	20	20

P4401 - BEAM LOADING

Span In	Max Allowable Uniform Load Lbs	Defl. at Uniform Load In	Uniform Loading at Deflection		
			Span/180 Lbs	Span/240 Lbs	Span/360 Lbs
24	2,140*	0.05	2,140*	2,140*	2,140*
36	1,420	0.11	1,420	1,420	1,240
48	1,070	0.20	1,070	1,040	700
60	850	0.32	850	670	450
72	710	0.46	620	460	310
84	610	0.63	450	340	230
96	530	0.81	350	260	170
108	470	1.03	280	210	140
120	430	1.29	220	170	110
144	360	1.86	150	120	80
168	310	2.54	110	90	60
192	270	3.31	90	70	NR
216	240	4.19	70	NR	NR
240	210	5.03	60	NR	NR

P4400 - COLUMN LOADING

Unbraced Height In	Maximum Allowable Load at Slot Face Lbs	Maximum Column Load Applied at C.G.			
		K = 0.65 Lbs	K = 0.80 Lbs	K = 1.0 Lbs	K = 1.2 Lbs
24	2,620	8,280	7,760	7,140	6,580
36	2,470	7,210	6,580	5,310	4,030
48	2,180	6,200	4,870	3,280	2,280
60	1,770	4,760	3,280	2,100	**
72	1,420	3,450	2,280	**	**
84	1,150	2,530	1,670	**	**
96	**	1,940	**	**	**

P4401 - COLUMN LOADING

Unbraced Height In	Maximum Allowable Load at Slot Face Lbs	Maximum Column Load Applied at C.G.			
		K = 0.65 Lbs	K = 0.80 Lbs	K = 1.0 Lbs	K = 1.2 Lbs
24	4,720	18,310	17,840	17,300	16,760
36	4,640	17,360	16,760	15,260	13,610
48	4,470	16,280	14,720	12,460	10,170
60	4,230	14,590	12,460	9,610	6,980
72	3,930	12,750	10,170	6,980	4,840
84	3,520	10,880	7,990	5,130	3,560
96	3,070	9,050	6,130	3,920	**
108	2,690	7,340	4,840	3,100	**
120	2,360	5,940	3,920	**	**

P4400/P4401 - ELEMENTS OF SECTION

Parameter	P4400		P4401	
Area of Section	0.424	In ²	0.849	In ²
Axis 1-1				
Moment of Inertia (I)	0.053	In ⁴	0.255	In ⁴
Section Modulus (S)	0.092	In ³	0.255	In ³
Radius of Gyration (r)	0.354	In	0.548	In
Axis 2-2				
Moment of Inertia (I)	0.161	In ⁴	0.322	In ⁴
Section Modulus (S)	0.198	In ³	0.396	In ³
Radius of Gyration (r)	0.616	In	0.616	In

Notes:

* Load limited by spot weld shear.

** KL/r > 200

NR = Not Recommended.

- Beam loads are given in total uniform load (W Lbs) not uniform load (w lbs/ft or w lbs/in).
- Beam loads are based on a simple span and assumed to be adequately laterally braced. Unbraced spans can reduce beam load carrying capacity. Refer to Page 62 for reduction factors for unbraced lengths.
- For pierced channel, multiply beam loads by the following factor:
"KO" Series95% **"T" Series85%**
"HS" Series90% **"SL" Series85%**
- Deduct channel weight from the beam loads.
- For concentrated midspan point loads, multiply beam loads by 50% and the corresponding deflection by 80%. For other load conditions refer to page 18.
- All beam loads are for bending about Axis 1-1.

P4400 - BEAM LOADING (METRIC)

Span mm	Max Allowable Uniform Load kN	Defl. at Uniform Load mm	Uniform Loading at Deflection		
			Span/180 kN	Span/240 kN	Span/360 kN
600	3.5	2.2	3.5	3.5	2.7
750	2.8	3.4	2.8	2.6	1.7
1000	2.1	6.0	2.0	1.5	1.0
1250	1.7	9.3	1.3	1.0	0.6
1500	1.4	13.4	0.9	0.6	0.5
1750	1.2	18.6	0.6	0.5	0.3
2000	1.0	23.6	0.5	0.4	0.2
2500	0.9	38.1	0.3	0.2	0.1
3000	0.7	55.5	0.2	0.2	0.1
3500	0.6	71.6	0.2	0.1	0.1

P4401 - BEAM LOADING (METRIC)

Span mm	Max Allowable Uniform Load kN	Defl. at Uniform Load mm	Uniform Loading at Deflection		
			Span/180 kN	Span/240 kN	Span/360 kN
600	9.7	1.2	9.7	9.7	9.7
750	7.9	2.0	7.9	7.9	7.9
1000	5.9	3.5	5.9	5.9	4.7
1250	4.7	5.5	4.7	4.5	3.0
1500	3.9	7.9	3.9	3.1	2.1
1750	3.4	10.6	3.1	2.3	1.5
2000	2.9	14.0	2.4	1.8	1.2
2500	2.4	21.8	1.5	1.1	0.8
3000	2.0	31.2	1.0	0.8	0.5
3500	1.7	42.6	0.8	0.6	0.4
4000	1.5	56.7	0.6	0.5	0.3
4500	1.3	70.9	0.5	0.4	0.2
5000	1.2	87.2	0.4	0.3	NR
6000	1.0	127.5	0.3	NR	NR

P4400 - COLUMN LOADING (METRIC)

Unbraced Height mm	Maximum Allowable Load at Slot Face kN	Maximum Column Load Applied at C.G.			
		K = 0.65 kN	K = 0.80 kN	K = 1.0 kN	K = 1.2 kN
600	11.9	37.7	35.4	32.6	30.1
750	11.6	35.2	32.6	29.5	24.5
1000	10.9	31.5	27.9	21.3	15.3
1250	9.7	27.4	21.3	14.2	9.8
1500	8.2	22.1	15.3	9.8	**
1750	6.8	17.1	11.3	7.2	**
2000	5.7	13.1	8.6	**	**
2500	**	8.4	**	**	**

P4401 - COLUMN LOADING (METRIC)

Unbraced Height mm	Maximum Allowable Load at Slot Face kN	Maximum Column Load Applied at C.G.			
		K = 0.65 kN	K = 0.80 kN	K = 1.0 kN	K = 1.2 kN
600	21.4	83.2	81.1	78.7	76.4
750	21.2	81.0	78.7	75.4	69.8
1000	20.9	77.7	73.6	65.8	57.3
1250	20.2	73.1	65.8	55.2	44.5
1500	19.3	66.8	57.3	44.5	32.7
1750	18.2	60.0	48.8	34.6	24.0
2000	16.8	53.1	40.5	26.4	18.4
2500	13.6	39.5	26.4	16.9	**
3000	10.9	27.9	18.4	**	**

P4400/P4401 - ELEMENTS OF SECTION (METRIC)

Parameter	P4100	P4101
Area of Section	2.74 cm ²	5.48 cm ²
Axis 1-1		
Moment of Inertia (I)	2.21 cm ⁴	10.61 cm ⁴
Section Modulus (S)	1.51 cm ³	4.18 cm ³
Radius of Gyration (r)	0.90 cm	1.39 cm
Axis 2-2		
Moment of Inertia (I)	6.70 cm ⁴	13.40 cm ⁴
Section Modulus (S)	3.24 cm ³	6.49 cm ³
Radius of Gyration (r)	1.57 cm	1.57 cm

Notes:

* Load limited by spot weld shear.

** KL/r > 200

NR = Not Recommended.

- Beam loads are given in total uniform load (W Lbs) not uniform load (w lbs/ft or w lbs/in).
- Beam loads are based on a simple span and assumed to be adequately laterally braced. Unbraced spans can reduce beam load carrying capacity. Refer to Page 62 for reduction factors for unbraced lengths.
- For pierced channel, multiply beam loads by the following factor:

"KO" Series	95%	"T" Series	85%
"HS" Series	90%	"SL" Series	85%
- Deduct channel weight from the beam loads.
- For concentrated midspan point loads, multiply beam loads by 50% and the corresponding deflection by 80%. For other load conditions refer to page 18.
- All beam loads are for bending about Axis 1-1.

P4520

GR PG

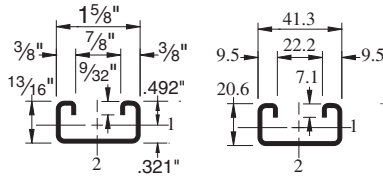
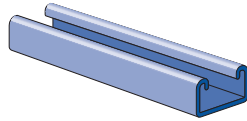

Wt/100 Ft: 131 Lbs (190 kg/100 m)
 Allowable Moment 1,615 In-Lbs (183 N•m)
 12 Gauge Nominal Thickness .105" (2.7mm)

P4521

GR PG

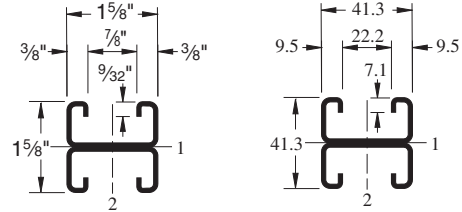
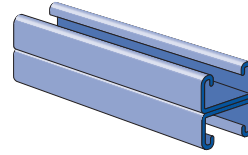

Wt/100 Ft: 262 Lbs (390 kg/100 m)
 Allowable Moment 4,540 In-Lbs (513 N•m)
 12 Gauge Nominal Thickness .105" (2.7mm)

P4520 HS

GR PG

9/16" (14.3) Dia. Holes
 1 7/8" (47.6) on Center

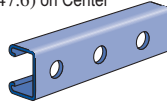

Wt/100 Ft: 120 Lbs (177 kg/100 m)

P4520 T

GR PG

Slots are
 1 1/8" (28.6) x 9/16" (14.3)
 2" (50.8) on Center

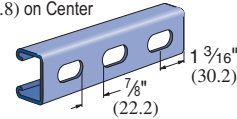

Wt/100 Ft: 120 Lbs (177 kg/100 m)

P4520 SL

GR PG

Slots are
 3" (76.2) x 1 3/32" (10.3)
 4" (101.6) on Center

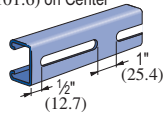

Wt/100 Ft: 118 Lbs (175 kg/100 m)

CHANNEL NUTS (REFER TO PAGES 73,74 FOR DETAILS)

SEE PAGE 73, 74



P4006-0832
 P4006-1024
 P4006-1420
 P4007
 P4008
 P4009
 P4010



P4006T1420
 P4008T
 P4010T



P4012
 P4023



P3006-0832
 P3006-1024
 P3006-1420
 P3007
 P3008
 P3009
 P3013



P3016-0632
 P3016-0832
 P3016-1024
 P3016-1420

Channel Finishes: PL, GR, HG, PG, ZD; Standard Lengths: 10' & 20'



1 5/8" Channel

Telestrut

Nuts & Hardware

General Fittings

Pipe/Conduit Supports

Electrical Fittings

Concrete Inserts

Solar

Unipier®

P4520 - BEAM LOADING

Span In	Max Allowable Uniform Load Lbs	Defl. at Uniform Load In	Uniform Loading at Deflection		
			Span/180 Lbs	Span/240 Lbs	Span/360 Lbs
24	540	0.11	540	510	340
36	360	0.24	300	220	150
48	270	0.43	170	130	80
60	220	0.68	110	80	50
72	180	0.96	70	60	40
84	150	1.27	60	40	30
96	130	1.65	40	30	20
108	120	2.16	30	20	20
120	110	2.72	30	20	NR
144	90	3.84	20	NR	NR

P4521 - BEAM LOADING

Span In	Max Allowable Uniform Load Lbs	Defl. at Uniform Load In	Uniform Loading at Deflection		
			Span/180 Lbs	Span/240 Lbs	Span/360 Lbs
24	1,510	0.06	1,510	1,510	1,510
36	1,010	0.14	1,010	1,010	710
48	760	0.25	760	600	400
60	610	0.40	510	380	260
72	500	0.56	360	270	180
84	430	0.77	260	200	130
96	380	1.01	200	150	100
108	340	1.29	160	120	80
120	300	1.56	130	100	60
144	250	2.25	90	70	40
168	220	3.14	70	50	NR
192	190	4.05	50	NR	NR
216	170	5.16	NR	NR	NR
240	150	6.24	NR	NR	NR

P4520 - COLUMN LOADING

Unbraced Height In	Maximum Allowable Load at Slot Face Lbs	Maximum Column Load Applied at C.G.			
		K = 0.65 Lbs	K = 0.80 Lbs	K = 1.0 Lbs	K = 1.2 Lbs
24	2,250	7,480	6,800	5,820	4,810
36	1,980	5,950	4,810	3,380	2,350
48	1,580	4,310	2,970	1,900	**
60	1,210	2,880	1,900	**	**
72	950	2,000	**	**	**

P4521 - COLUMN LOADING

Unbraced Height In	Maximum Allowable Load at Slot Face Lbs	Maximum Column Load Applied at C.G.			
		K = 0.65 Lbs	K = 0.80 Lbs	K = 1.0 Lbs	K = 1.2 Lbs
24	4,140	16,490	15,980	14,970	13,810
36	3,980	15,100	13,810	11,910	9,940
48	3,730	13,190	11,260	8,650	6,270
60	3,390	11,090	8,650	5,780	4,010
72	2,950	8,970	6,270	4,010	2,790
84	2,510	6,980	4,610	2,950	**
96	2,130	5,340	3,530	**	**
108	1,820	4,220	2,790	**	**
120	**	3,420	**	**	**

P4520/P4521 - ELEMENTS OF SECTION

Parameter	P4400		P4401	
Area of Section	0.384	In ²	0.770	In ²
Axis 1-1				
Moment of Inertia (I)	0.031	In ⁴	0.146	In ⁴
Section Modulus (S)	0.064	In ³	0.180	In ³
Radius of Gyration (r)	0.283	In	0.436	In
Axis 2-2				
Moment of Inertia (I)	0.138	In ⁴	0.277	In ⁴
Section Modulus (S)	0.170	In ³	0.340	In ³
Radius of Gyration (r)	0.599	In	0.599	In

Notes:

* Load limited by spot weld shear.

** KL/r > 200

NR = Not Recommended.

- Beam loads are given in total uniform load (W Lbs) not uniform load (w lbs/ft or w lbs/in).
- Beam loads are based on a simple span and assumed to be adequately laterally braced. Unbraced spans can reduce beam load carrying capacity. Refer to Page 62 for reduction factors for unbraced lengths.
- For pierced channel, multiply beam loads by the following factor:

"KO" Series	95%	"T" Series	85%
"HS" Series	90%	"SL" Series	85%
- Deduct channel weight from the beam loads.
- For concentrated midspan point loads, multiply beam loads by 50% and the corresponding deflection by 80%. For other load conditions refer to page 18.
- All beam loads are for bending about Axis 1-1.

P4520 - BEAM LOADING (METRIC)

Span mm	Max Allowable Uniform Load kN	Defl. at Uniform Load mm	Uniform Loading at Deflection		
			Span/180 kN	Span/240 kN	Span/360 kN
600	2.5	2.6	2.5	2.4	1.6
750	2.0	4.1	2.0	1.5	1.0
1000	1.5	7.3	1.1	0.9	0.6
1250	1.2	11.3	0.7	0.5	0.4
1500	1.0	16.5	0.5	0.4	0.3
1750	0.9	22.6	0.4	0.3	0.2
2000	0.7	28.4	0.3	0.2	0.1
2500	0.6	45.0	0.2	0.1	0.1
3000	0.5	65.8	0.1	0.1	NR
3500	0.4	85.5	0.1	0.1	NR

P4521 - BEAM LOADING (METRIC)

Span mm	Max Allowable Uniform Load kN	Defl. at Uniform Load mm	Uniform Loading at Deflection		
			Span/180 kN	Span/240 kN	Span/360 kN
600	7.0	1.6	7.0	7.0	7.0
750	5.6	2.4	5.6	5.6	4.8
1000	4.2	4.3	4.2	4.0	2.7
1250	3.4	6.7	3.4	2.6	1.7
1500	2.8	9.6	2.4	1.8	1.2
1750	2.4	13.3	1.8	1.3	0.9
2000	2.1	17.2	1.4	1.0	0.7
2500	1.7	27.0	0.9	0.6	0.5
3000	1.4	39.1	0.6	0.5	0.3
3500	1.2	52.0	0.5	0.3	0.2
4000	1.0	68.7	0.3	0.3	0.2
4500	0.9	85.1	0.3	0.2	NR
5000	0.8	105.0	0.2	NR	NR
6000	0.7	151.2	NR	NR	NR

P4520 - COLUMN LOADING (METRIC)

Unbraced Height mm	Maximum Allowable Load at Slot Face kN	Maximum Column Load Applied at C.G.			
		K = 0.65 kN	K = 0.80 kN	K = 1.0 kN	K = 1.2 kN
600	10.3	34.1	31.1	26.8	22.2
750	9.7	30.9	26.8	21.1	15.8
1000	8.5	24.9	19.3	12.8	8.9
1250	6.9	18.9	12.8	8.2	**
1500	5.6	13.5	8.9	**	**
1750	4.6	9.9	6.5	**	**

P4521 - COLUMN LOADING (METRIC)

Unbraced Height mm	Maximum Allowable Load at Slot Face kN	Maximum Column Load Applied at C.G.			
		K = 0.65 kN	K = 0.80 kN	K = 1.0 kN	K = 1.2 kN
600	18.8	74.9	72.8	68.3	63.1
750	18.5	72.5	68.3	61.8	54.7
1000	17.8	66.2	59.5	49.8	40.1
1250	16.8	58.9	49.8	37.8	27.0
1500	15.5	51.1	40.1	27.0	18.8
1750	14.0	43.1	31.1	19.9	13.8
2000	12.2	35.5	23.8	15.2	**
2500	9.3	23.0	15.2	**	**
3000	**	16.0	**	**	**

P4520/P4521 - ELEMENTS OF SECTION (METRIC)

Parameter	P4100	P4101
Area of Section	2.48 cm ²	4.97 cm ²
Axis 1-1		
Moment of Inertia (I)	1.29 cm ⁴	6.08 cm ⁴
Section Modulus (S)	1.05 cm ³	2.95 cm ³
Radius of Gyration (r)	0.72 cm	1.11 cm
Axis 2-2		
Moment of Inertia (I)	5.74 cm ⁴	11.53 cm ⁴
Section Modulus (S)	2.79 cm ³	5.57 cm ³
Radius of Gyration (r)	1.52 cm	1.53 cm

Notes:

* Load limited by spot weld shear.

** KL/r > 200

NR = Not Recommended.

- Beam loads are given in total uniform load (W Lbs) not uniform load (w lbs/ft or w lbs/in).
- Beam loads are based on a simple span and assumed to be adequately laterally braced. Unbraced spans can reduce beam load carrying capacity. Refer to Page 62 for reduction factors for unbraced lengths.
- For pierced channel, multiply beam loads by the following factor:
"KO" Series.....95% **"T" Series85%**
"HS" Series90% **"SL" Series85%**
- Deduct channel weight from the beam loads.
- For concentrated midspan point loads, multiply beam loads by 50% and the corresponding deflection by 80%. For other load conditions refer to page 18.
- All beam loads are for bending about Axis 1-1.



1 5/8" Channel
Telestrut
Nuts & Hardware
General Fittings
Pipe/Conduit Supports
Electrical Fittings
Concrete Inserts
Solar
Unipier®

P5000

GR PL PG

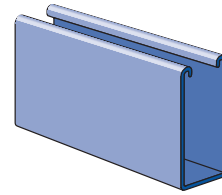
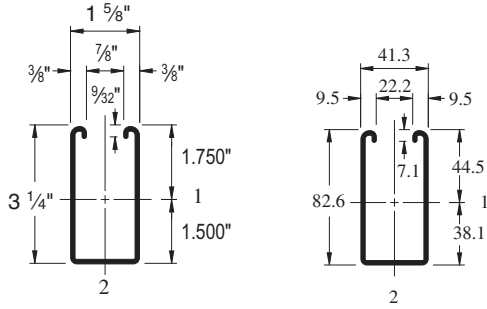

Wt/100 Ft: 305 Lbs (454 kg/100 m)
Allowable Moment 15,770 In-Lbs (1,780 N·m)
12 Gauge Nominal Thickness .105" (2.7mm)

P5001

GR PG

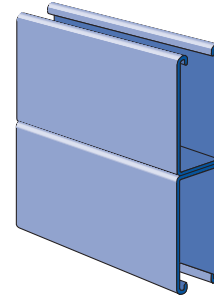
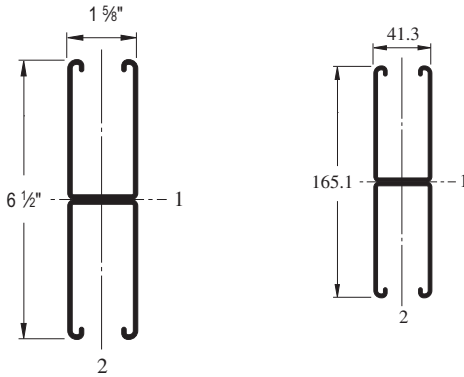

Wt/100 Ft: 610 Lbs (907 kg/100 m)
Allowable Moment 48,180 In-Lbs (5,440 N·m)
12 Gauge Nominal Thickness .105" (2.7mm)

P5000 HS

GR PG

9/16" (14.3) Dia. Holes
1 7/8" (47.6) on Center

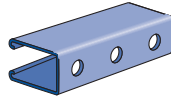

Wt/100 Ft: 300 Lbs (446 kg/100 m)

P5000 KO

GR PG

7/8" (22.2) Knockouts
6" (152.4) on Center

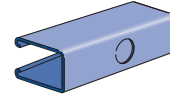

Wt/100 Ft: 305 Lbs (454 kg/100 m)

P5000 SL

GR PG

Slots are
3" (76.2) x 1 9/32" (10.3)
4" (101.6) on Center

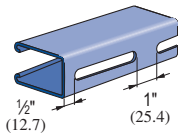

Wt/100 Ft: 300 Lbs (446 kg/100 m)

P5000 T

GR PG

Slots are
1 1/8" (28.6) x 9/16" (14.3)
2" (50.8) on Center

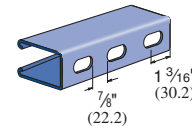

Wt/100 Ft: 300 Lbs (446 kg/100 m)

CHANNEL NUTS (REFER TO PAGES 73,74 FOR DETAILS)

SEE PAGE 73, 74

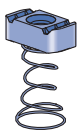

P5506-0832
P5506-1024
P5506-1420
P5507
P5508
P5509
P5510



P1006T1420
P1008T
P1010T



P1012
P1023
P1024



P3006-0832
P3006-1024
P3006-1420
P3007
P3008
P3009
P3010



P3016-0632
P3016-0832
P3016-1024
P3016-1420

Channel Finishes: PL, GR, HG, PG, ZD; Standard Lengths: 10' & 20'

P5000 - BEAM LOADING

Span In	Max Allowable Uniform Load Lbs	Defl. at Uniform Load In	Uniform Loading at Deflection		
			Span/180 Lbs	Span/240 Lbs	Span/360 Lbs
24	5,260	0.03	5,260	5,260	5,260
36	3,500	0.07	3,500	3,500	3,500
48	2,630	0.12	2,630	2,630	2,630
60	2,100	0.18	2,100	2,100	1,920
72	1,750	0.26	1,750	1,750	1,330
84	1,500	0.36	1,500	1,470	980
96	1,310	0.47	1,310	1,120	750
108	1,170	0.59	1,170	890	590
120	1,050	0.73	960	720	480
144	880	1.06	670	500	330
168	750	1.43	490	370	240
192	660	1.88	370	280	190
216	580	2.35	300	220	150
240	530	2.95	240	180	120

P5001 - BEAM LOADING

Span In	Max Allowable Uniform Load Lbs	Defl. at Uniform Load In	Uniform Loading at Deflection		
			Span/180 Lbs	Span/240 Lbs	Span/360 Lbs
24	6,890*	0.01	6,890*	6,890*	6,890*
36	6,890*	0.02	6,890*	6,890*	6,890*
48	6,890*	0.05	6,890*	6,890*	6,890*
60	6,420	0.10	6,420	6,420	6,420
72	5,350	0.14	5,350	5,350	5,350
84	4,590	0.19	4,590	4,590	4,590
96	4,020	0.25	4,020	4,020	4,020
108	3,570	0.32	3,570	3,570	3,360
120	3,210	0.39	3,210	3,210	2,720
144	2,680	0.57	2,680	2,680	1,890
168	2,290	0.77	2,290	2,080	1,390
192	2,010	1.01	2,010	1,590	1,060
216	1,780	1.27	1,680	1,260	840
240	1,610	1.58	1,360	1,020	680

P5000 - COLUMN LOADING

Unbraced Height In	Maximum Allowable Load at Slot Face Lbs	Maximum Column Load Applied at C.G.			
		K = 0.65 Lbs	K = 0.80 Lbs	K = 1.0 Lbs	K = 1.2 Lbs
24	5,650	16,870	15,180	12,850	10,600
36	4,690	13,140	10,600	7,650	5,660
48	3,560	9,550	6,860	4,790	3,660
60	2,730	6,680	4,790	3,450	2,710
72	2,160	4,980	3,660	2,710	2,170
84	1,760	3,950	2,960	2,240	1,820
96	1,500	3,270	2,500	1,930	1,580
108	1,310	2,800	2,170	1,690	1,390
120	1,170	2,450	1,930	1,510	**
144	980	1,980	1,580	**	**
168	850	1,670	1,340	**	**

P5001 - COLUMN LOADING

Unbraced Height In	Maximum Allowable Load at Slot Face Lbs	Maximum Column Load Applied at C.G.			
		K = 0.65 Lbs	K = 0.80 Lbs	K = 1.0 Lbs	K = 1.2 Lbs
24	10,670	39,230	38,030	36,210	34,240
36	10,350	36,450	34,240	31,200	28,260
48	9,940	33,220	30,200	26,430	23,190
60	9,290	29,950	26,430	22,470	19,380
72	8,560	26,880	23,190	19,380	16,450
84	7,860	24,140	20,520	17,040	12,090
96	7,220	21,790	18,370	13,330	9,250
108	6,600	19,790	16,450	10,530	7,310
120	5,760	18,130	13,330	8,530	**
144	4,390	14,020	9,250	**	**
168	3,420	10,300	6,800	**	**

P5000/P5001 - ELEMENTS OF SECTION

Parameter	P5000		P5001	
Area of Section	0.897	In ²	1.793	In ²
Axis 1-1				
Moment of Inertia (I)	1.098	In ⁴	6.227	In ⁴
Section Modulus (S)	0.627	In ³	1.916	In ³
Radius of Gyration (r)	1.107	In	1.864	In
Axis 2-2				
Moment of Inertia (I)	0.433	In ⁴	0.866	In ⁴
Section Modulus (S)	0.533	In ³	1.066	In ³
Radius of Gyration (r)	0.695	In	0.695	In

Notes:

* Load limited by spot weld shear.

** KL/r > 200

NR = Not Recommended.

- Beam loads are given in total uniform load (W Lbs) not uniform load (w lbs/ft or w lbs/in).
- Beam loads are based on a simple span and assumed to be adequately laterally braced. Unbraced spans can reduce beam load carrying capacity. Refer to Page 62 for reduction factors for unbraced lengths.
- For pierced channel, multiply beam loads by the following factor:
"KO" Series95% **"T" Series85%**
"HS" Series90% **"SL" Series85%**
- Deduct channel weight from the beam loads.
- For concentrated midspan point loads, multiply beam loads by 50% and the corresponding deflection by 80%. For other load conditions refer to page 18.
- All beam loads are for bending about Axis 1-1.

P5000 - BEAM LOADING (METRIC)

Span mm	Max Allowable Uniform Load kN	Defl. at Uniform Load mm	Uniform Loading at Deflection		
			Span/180 kN	Span/240 kN	Span/360 kN
600	23.8	1	23.8	23.8	23.8
750	19.0	1	19.0	19.0	19.0
1,000	14.2	2	14.2	14.2	14.2
1,250	11.4	3	11.4	11.4	11.4
1,500	9.5	5	9.5	9.5	8.8
1,750	8.1	6	8.1	8.1	6.5
2,000	7.1	8	7.1	7.1	4.9
2,500	5.7	12	5.7	4.8	3.2
3,000	4.8	18	4.4	3.3	2.2
3,500	4.1	25	3.2	2.4	1.6
4,000	3.6	32	2.5	1.9	1.2
4,500	3.2	40	2.0	1.5	1.0
5,000	2.8	50	1.6	1.2	0.8
6,000	2.4	71	1.1	0.8	0.5

P5001 - BEAM LOADING (METRIC)

Span mm	Max Allowable Uniform Load kN	Defl. at Uniform Load mm	Uniform Loading at Deflection		
			Span/180 kN	Span/240 kN	Span/360 kN
600	30.6 *	0	30.6 *	30.6 *	30.6 *
750	30.6 *	0	30.6 *	30.6 *	30.6 *
1,000	30.6 *	1	30.6 *	30.6 *	30.6 *
1,250	30.6 *	1	30.6 *	30.6 *	30.6 *
1,500	29.0	2	29.0	29.0	29.0
1,750	24.9	3	24.9	24.9	24.9
2,000	21.8	4	21.8	21.8	21.8
2,500	17.4	7	17.4	17.4	17.4
3,000	14.5	10	14.5	14.5	12.5
3,500	12.5	13	12.5	12.5	9.2
4,000	10.9	17	10.9	10.5	7.0
4,500	9.7	22	9.7	8.3	5.6
5,000	8.7	27	8.7	6.8	4.5
6,000	7.2	39	6.2	4.7	3.1

P5000 - COLUMN LOADING (METRIC)

Unbraced Height mm	Maximum Allowable Load at Slot Face kN	Maximum Column Load Applied at C.G.			
		K = 0.65 kN	K = 0.80 kN	K = 1.0 kN	K = 1.2 kN
600	25.2	75.5	68.1	58.0	48.0
750	23.5	67.5	58.0	45.7	35.0
1,000	19.4	53.7	41.9	29.3	21.8
1,250	15.4	41.0	29.3	20.5	15.7
1,500	12.4	30.5	21.8	15.7	12.3
1,750	10.2	23.8	17.3	12.8	10.2
2,000	8.5	19.3	14.4	10.8	8.7
2,250	7.3	16.3	12.3	9.4	7.6
2,500	6.5	14.1	10.8	8.3	6.9
2,750	5.8	12.4	9.6	7.5	6.2

P5001 - COLUMN LOADING (METRIC)

Unbraced Height mm	Maximum Allowable Load at Slot Face kN	Maximum Column Load Applied at C.G.			
		K = 0.65 kN	K = 0.80 kN	K = 1.0 kN	K = 1.2 kN
600	47.5	174.9	169.7	161.7	153.2
750	46.8	169.2	161.7	150.9	139.8
1,000	45.6	158.2	147.2	132.6	118.8
1,250	44.0	146.3	132.6	115.6	101.2
1,500	41.6	134.3	118.8	101.2	87.4
1,750	38.9	122.9	106.6	89.4	76.8
2,000	36.3	112.5	96.2	80.0	61.2
2,250	33.9	103.2	87.4	69.6	48.4
2,500	31.6	95.0	80.0	56.4	39.1
2,750	29.3	87.8	72.9	46.6	32.4

P5000/P5001 - ELEMENTS OF SECTION (METRIC)

Parameter	P5000	P5001
Area of Section	5.78 cm ²	11.57 cm ²
Axis 1-1		
Moment of Inertia (I)	45.70 cm ⁴	259.17 cm ⁴
Section Modulus (S)	10.28 cm ³	31.40 cm ³
Radius of Gyration (r)	2.81 cm	4.73 cm
Axis 2-2		
Moment of Inertia (I)	18.02 cm ⁴	36.04 cm ⁴
Section Modulus (S)	8.73 cm ³	17.46 cm ³
Radius of Gyration (r)	1.77 cm	1.77 cm

Notes:

* Load limited by spot weld shear.

** KL/r > 200

NR = Not Recommended.

- Beam loads are given in total uniform load (W Lbs) not uniform load (w lbs/ft or w lbs/in).
- Beam loads are based on a simple span and assumed to be adequately laterally braced. Unbraced spans can reduce beam load carrying capacity. Refer to Page 62 for reduction factors for unbraced lengths.
- For pierced channel, multiply beam loads by the following factor:

"KO" Series	95%	"T" Series	85%
"HS" Series	90%	"SL" Series	85%
- Deduct channel weight from the beam loads.
- For concentrated midspan point loads, multiply beam loads by 50% and the corresponding deflection by 80%. For other load conditions refer to page 18.
- All beam loads are for bending about Axis 1-1.

P5500

GR PG

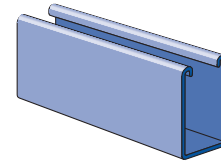
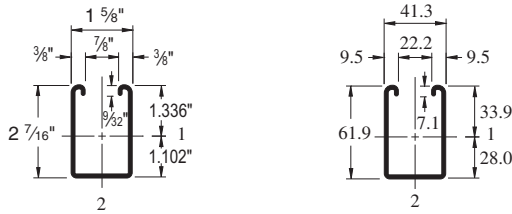

Wt/100 Ft: 247 Lbs (367 kg/100 m)
 Allowable Moment 9,820 In-Lbs (1,110 N·m)
 12 Gauge Nominal Thickness .105" (2.7mm)

P5501

GR PG

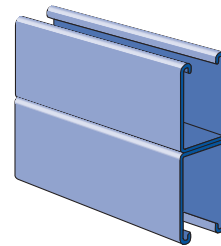
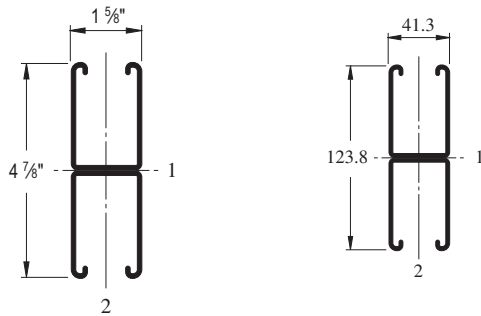

Wt/100 Ft: 494 Lbs (734 kg/100 m)
 Allowable Moment 28,940 In-Lbs (3,270 N·m)
 12 Gauge Nominal Thickness .105" (2.7mm)

P5500 HS

GR PG

P5500 KO

GR PG

P5500 SL

GR PG

9/16" (14.3) Dia. Holes
 1 7/8" (47.6) on Center

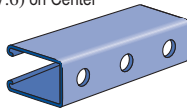

Wt/100 Ft: 242 Lbs (360 kg/100 m)

7/8" (22.2) Knockouts
 6" (152.4) on Center

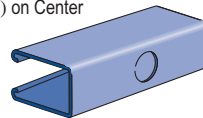

Wt/100 Ft: 247 Lbs (368 kg/100 m)

Slots are
 3" (76.2) x 1 3/32" (10.3)
 4" (101.6) on Center

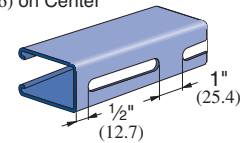

Wt/100 Ft: 242 Lbs (360 kg/100 m)

P5500 T

GR PG

Slots are
 1 1/8" (28.6) x 9/16" (14.3)
 2" (50.8) on Center

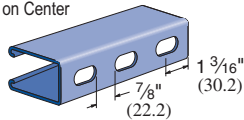

Wt/100 Ft: 242 Lbs (360 kg/100 m)

CHANNEL NUTS (REFER TO PAGES 73,74 FOR DETAILS)

SEE PAGE 73, 74

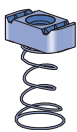

P5506-0832
 P5506-1024
 P5506-1420
 P5507
 P5508
 P5509
 P5510



P1006T1420
 P1008T
 P1010T



P1012
 P1023
 P1024



P3006-0832
 P3006-1024
 P3006-1420
 P3007
 P3008
 P3009
 P3010



P3016-0632
 P3016-0832
 P3016-1024
 P3016-1420

Channel Finishes: PL, GR, HG, PG, ZD; Standard Lengths: 10' & 20'

P5500 - BEAM LOADING

Span In	Max Allowable Uniform Load Lbs	Defl. at Uniform Load In	Uniform Loading at Deflection		
			Span/180 Lbs	Span/240 Lbs	Span/360 Lbs
24	3,270	0.04	3,270	3,270	3,270
36	2,180	0.09	2,180	2,180	2,180
48	1,640	0.15	1,640	1,640	1,420
60	1,310	0.24	1,310	1,310	910
72	1,090	0.34	1,090	950	630
84	940	0.47	930	700	470
96	820	0.61	710	530	360
108	730	0.78	560	420	280
120	650	0.95	460	340	230
144	550	1.39	320	240	160
168	470	1.89	230	170	120
192	410	2.46	180	130	90
216	360	3.07	140	110	70
240	330	3.86	110	90	60

P5501 - BEAM LOADING

Span In	Max Allowable Uniform Load Lbs	Defl. at Uniform Load In	Uniform Loading at Deflection		
			Span/180 Lbs	Span/240 Lbs	Span/360 Lbs
24	5,220*	0.01	5,220*	5,220*	5,220*
36	5,220*	0.04	5,220*	5,220*	5,220*
48	4,820	0.08	4,820	4,820	4,820
60	3,860	0.13	3,860	3,860	3,860
72	3,220	0.19	3,220	3,220	3,220
84	2,760	0.26	2,760	2,760	2,500
96	2,410	0.34	2,410	2,410	1,920
108	2,140	0.42	2,140	2,140	1,510
120	1,930	0.52	1,930	1,840	1,230
144	1,610	0.76	1,610	1,280	850
168	1,380	1.03	1,250	940	630
192	1,210	1.35	960	720	480
216	1,070	1.70	760	570	380
240	960	2.09	610	460	310

P5500 - COLUMN LOADING

Unbraced Height In	Maximum Allowable Load at Slot Face Lbs	Maximum Column Load Applied at C.G.			
		K = 0.65 Lbs	K = 0.80 Lbs	K = 1.0 Lbs	K = 1.2 Lbs
24	4,640	13,840	12,570	10,840	9,190
36	3,970	11,050	9,190	7,030	5,370
48	3,180	8,420	6,390	4,620	3,630
60	2,550	6,250	4,620	3,450	2,780
72	2,120	4,790	3,630	2,780	2,260
84	1,810	3,890	3,010	2,330	1,910
96	1,580	3,290	2,580	2,020	1,650
108	1,400	2,860	2,260	1,770	1,440
120	1,270	2,530	2,020	1,580	**
144	1,060	2,070	1,650	**	**
168	920	1,750	1,380	**	**

P5501 - COLUMN LOADING

Unbraced Height In	Maximum Allowable Load at Slot Face Lbs	Maximum Column Load Applied at C.G.			
		K = 0.65 Lbs	K = 0.80 Lbs	K = 1.0 Lbs	K = 1.2 Lbs
24	8,580	31,810	30,880	29,520	28,100
36	8,350	29,700	28,100	26,000	24,070
48	8,080	27,390	25,330	22,910	20,940
60	7,720	25,170	22,910	20,510	17,170
72	7,270	23,190	20,940	17,170	12,700
84	6,780	21,510	18,740	13,430	9,330
96	6,130	20,110	15,630	10,290	7,150
108	5,450	17,750	12,700	8,130	5,650
120	4,800	15,260	10,290	6,590	**
144	3,760	10,830	7,150	**	**
168	2,970	7,950	5,250	**	**

P5500/P5501 - ELEMENTS OF SECTION

Parameter	P5500		P5501	
Area of Section	0.726	In ²	1.452	In ²
Axis 1-1				
Moment of Inertia (I)	0.522	In ⁴	2.805	In ⁴
Section Modulus (S)	0.390	In ³	1.151	In ³
Radius of Gyration (r)	0.848	In	1.390	In
Axis 2-2				
Moment of Inertia (I)	0.334	In ⁴	0.669	In ⁴
Section Modulus (S)	0.411	In ³	0.823	In ³
Radius of Gyration (r)	0.679	In	0.679	In

Notes:

* Load limited by spot weld shear.

** KL/r > 200

NR = Not Recommended.

- Beam loads are given in total uniform load (W Lbs) not uniform load (w lbs/ft or w lbs/in).
- Beam loads are based on a simple span and assumed to be adequately laterally braced. Unbraced spans can reduce beam load carrying capacity. Refer to Page 62 for reduction factors for unbraced lengths.
- For pierced channel, multiply beam loads by the following factor:

"KO" Series	95%	"T" Series	85%
"HS" Series	90%	"SL" Series	85%
- Deduct channel weight from the beam loads.
- For concentrated midspan point loads, multiply beam loads by 50% and the corresponding deflection by 80%. For other load conditions refer to page 18.
- All beam loads are for bending about Axis 1-1.

P5500 - BEAM LOADING (METRIC)

Span mm	Max Allowable Uniform Load kN	Defl. at Uniform Load mm	Uniform Loading at Deflection		
			Span/180 kN	Span/240 kN	Span/360 kN
600	14.8	1	14.8	14.8	14.8
750	11.8	1	11.8	11.8	11.8
1,000	8.9	3	8.9	8.9	8.9
1,250	7.1	4	7.1	7.1	6.1
1,500	5.9	6	5.9	5.9	4.2
1,750	5.1	8	5.1	4.6	3.1
2,000	4.5	10	4.5	3.5	2.4
2,500	3.6	16	3.0	2.3	1.5
3,000	3.0	24	2.1	1.6	1.1
3,500	2.5	32	1.6	1.2	0.8
4,000	2.2	42	1.2	0.9	0.6
4,500	2.0	53	0.9	0.7	0.4
5,000	1.8	66	0.8	0.6	0.4
6,000	1.5	94	0.5	0.4	0.3

P5501 - BEAM LOADING (METRIC)

Span mm	Max Allowable Uniform Load kN	Defl. at Uniform Load mm	Uniform Loading at Deflection		
			Span/180 kN	Span/240 kN	Span/360 kN
600	23.2 *	0	23.2 *	23.2 *	23.2 *
750	23.2 *	1	23.2 *	23.2 *	23.2 *
1,000	23.2 *	1	23.2 *	23.2 *	23.2 *
1,250	20.9	2	20.9	20.9	20.9
1,500	17.4	3	17.4	17.4	17.4
1,750	14.9	4	14.9	14.9	14.9
2,000	13.1	6	13.1	13.1	12.7
2,500	10.5	9	10.5	10.5	8.1
3,000	8.7	13	8.7	8.5	5.6
3,500	7.5	18	7.5	6.2	4.1
4,000	6.5	23	6.3	4.8	3.2
4,500	5.8	29	5.0	3.7	2.5
5,000	5.2	36	4.1	3.0	2.0
6,000	4.4	52	2.8	2.1	1.4

P5500 - COLUMN LOADING (METRIC)

Unbraced Height mm	Maximum Allowable Load at Slot Face kN	Maximum Column Load Applied at C.G.			
		K = 0.65 kN	K = 0.80 kN	K = 1.0 kN	K = 1.2 kN
600	20.7	61.9	56.4	48.8	41.6
750	19.6	55.9	48.8	39.8	31.9
1,000	16.7	45.7	37.0	27.4	21.0
1,250	13.8	36.4	27.4	19.9	15.7
1,500	11.5	28.5	21.0	15.7	12.6
1,750	9.8	22.6	17.1	13.0	10.6
2,000	8.6	18.9	14.5	11.2	9.1
2,250	7.6	16.2	12.6	9.8	8.0
2,500	6.9	14.2	11.2	8.7	7.2
2,750	6.2	12.7	10.1	7.9	6.4

P5501 - COLUMN LOADING (METRIC)

Unbraced Height mm	Maximum Allowable Load at Slot Face kN	Maximum Column Load Applied at C.G.			
		K = 0.65 kN	K = 0.80 kN	K = 1.0 kN	K = 1.2 kN
600	38.2	141.5	137.4	131.3	125.0
750	37.1	132.1	125.0	115.6	107.1
1,000	35.9	121.8	112.7	101.9	93.1
1,250	34.3	112.0	101.9	91.2	76.4
1,500	32.3	103.2	93.1	76.4	56.5
1,750	30.2	95.7	83.4	59.7	41.5
2,000	27.3	89.5	69.5	45.8	31.8
2,500	24.2	79.0	56.5	36.2	25.1
3,000	21.3	67.9	45.8	29.3	**
3,500	16.7	48.2	31.8	**	**
4,000	13.2	35.4	23.3	**	**

P5500/P5501 - ELEMENTS OF SECTION (METRIC)

Parameter	P5500	P5501
Area of Section	4.68 cm ²	9.37 cm ²
Axis 1-1		
Moment of Inertia (I)	21.71 cm ⁴	116.76 cm ⁴
Section Modulus (S)	6.40 cm ³	18.86 cm ³
Radius of Gyration (r)	2.15 cm	3.53 cm
Axis 2-2		
Moment of Inertia (I)	13.91 cm ⁴	27.83 cm ⁴
Section Modulus (S)	6.74 cm ³	13.48 cm ³
Radius of Gyration (r)	1.72 cm	1.72 cm

Notes:

* Load limited by spot weld shear.

** KL/r > 200

NR = Not Recommended.

- Beam loads are given in total uniform load (W Lbs) not uniform load (w lbs/ft or w lbs/in).
- Beam loads are based on a simple span and assumed to be adequately laterally braced. Unbraced spans can reduce beam load carrying capacity. Refer to Page 62 for reduction factors for unbraced lengths.
- For pierced channel, multiply beam loads by the following factor:
"KO" Series95% **"T" Series85%**
"HS" Series90% **"SL" Series85%**
- Deduct channel weight from the beam loads.
- For concentrated midspan point loads, multiply beam loads by 50% and the corresponding deflection by 80%. For other load conditions refer to page 18.
- All beam loads are for bending about Axis 1-1.



1 5/8" Channel
Telestrut
Nuts & Hardware
General Fittings
Pipe/Conduit Supports
Electrical Fittings
Concrete Inserts
Solar
Unipier®

P1184

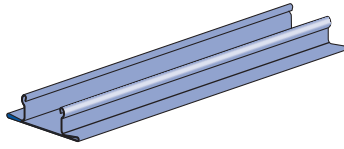

Finish: PG, PL
Standard length: 10' (3m)

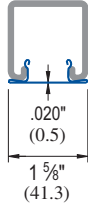

Wt/100 Ft: 27 Lbs (40.2 kg/100 m)

P1184 P

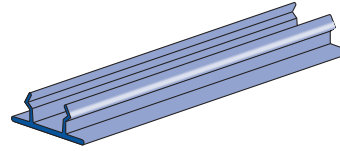

Material: Paintable PVC
Color: Green, Grey
Standard length: 10' (3m)

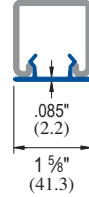

Wt/100 Ft: 11 Lbs (16.5 kg/100 m)

P3184

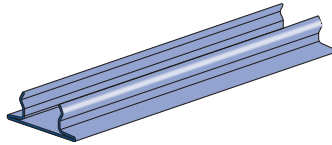

Finish: GR, PG, PL
Standard length: 10' (3m)

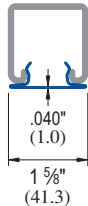

Wt/100 Ft: 47 Lbs (69.9 kg/100 m)

P3184 P

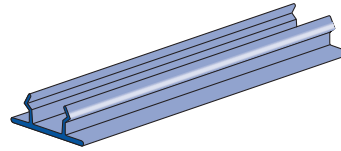

Material : G.E. Noryl® Plastic
Color: Green, Grey and White
Standard length: 10' (3m)

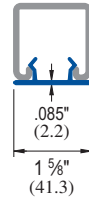

Wt/100 Ft: 9.4 Lbs (14.0 kg/100 m)

P3184 F

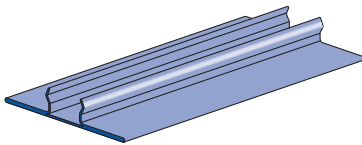

Finish: GR, PG, PL
Standard length: 16' (4.9m)

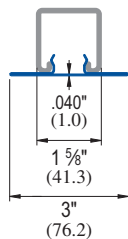

Wt/100 Ft: 90 Lbs (134 kg/100 m)

P3712 P

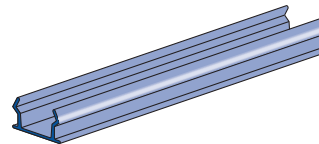

Material: Plastic
Color: Black
Standard length: 10' (3m)
Note: Use with P3170, P3270, and P3370 series concrete insert.

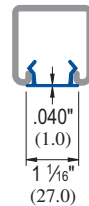

Wt/100 Ft: 5.4 Lbs (8.0 kg/100 m)

P1280

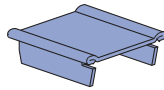

Use with P1000
Material: .060" (1.5)

Wt/100 pcs: 11 Lbs (5.0 Kg.)

P2407, P3280, P3380

END CAPS



Part Number	Fits Channel	Wt/100 pcs Lbs (kg)
P2407	P1000	10 4.5
P3280	P3000	8 3.6
P3380*	P3300	5 2.3

P1280 A, P2280 A

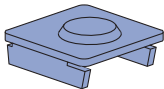

Material: .075" (1.9)

Part Number	Use With Channel	Wt/100 pcs Lbs (kg)
P1280A	P1000	11 5.0
P2280A	P2000	11 5.0

P1180, P2280, P4280, P5280, P5580

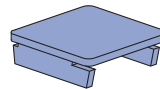

Material: .075" (1.9)

Part Number	Use With Channel	Wt/100 pcs Lbs (kg)
P1180	P1100	12 5.4
P2280	P2000	11 5.0
P4280	P4000	5 2.3
P5280	P5000	22 10.0
P5580	P5500	17 7.7

P2859

FRAME CAPS

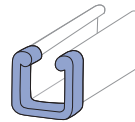

* Add color suffix:
GR - Green
WH - White
GY - Grey
"A" series frame caps available

Part Number*	Use With Channel	Wt/100 pcs Lbs (kg)
P2859-10	P1000	12 5.4
P2859-11	P1001	12 5.4
P2859-12	P3300	5 2.3
P2859-13	P5000	22 10.0
P2859-14	P5500	17 7.7

P2860

PLASTIC WHITE END CAPS

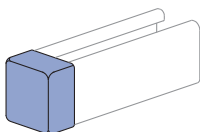

P2860-10

Use with P1000, P1100, P2000 channels & P9000 Telestrut.
Wt/100 pcs 3.4 Lbs (1.5 kg)

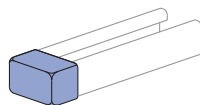

P2860-33

Use with P3300 channel.
Wt/100 pcs 2.5 Lbs (1.1 kg)

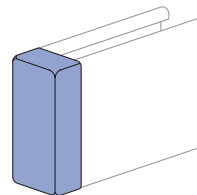

P2860-50

Use with P5000 & P1001 channels.
Wt/100 pcs 5 Lbs (2.3 kg)

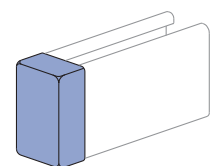

P2860-55

Use with P5500 channel.
Wt/100 pcs 4.7 Lbs (2.1 kg)



LATERAL BRACING LOAD REDUCTION CHARTS

Span		Single Channel										Double Channel											
Ft. (m)	In. (cm)	P1000	P1100	P2000	P3000	P3300	P4000	P4100	P4400	P4520	P5000	P5500	P1001	P1101	P2001	P3001	P3301	P4001	P4101	P4401	P4521	P5001	P5501
2 (0.61)	24 (61)	1.00	1.00	1.00	1.00	1.00	1.00	1.00	1.00	1.00	0.98	0.99	1.00	1.00	1.00	1.00	1.00	1.00	1.00	1.00	1.00	1.00	1.00
3 (0.91)	36 (91)	0.94	0.89	0.88	0.96	1.00	0.94	0.98	1.00	1.00	0.85	0.89	1.00	1.00	1.00	1.00	1.00	1.00	1.00	1.00	1.00	1.00	1.00
4 (1.22)	48 (122)	0.88	0.78	0.75	0.91	1.00	0.88	0.94	0.98	1.00	0.70	0.77	1.00	0.98	0.98	1.00	1.00	0.98	1.00	1.00	1.00	0.97	0.98
5 (1.52)	60 (152)	0.82	0.68	0.61	0.88	0.98	0.83	0.91	0.96	1.00	0.55	0.67	0.97	0.93	0.92	0.98	1.00	0.93	0.96	1.00	1.00	0.90	0.93
6 (1.83)	72 (183)	0.78	0.59	0.48	0.84	0.97	0.79	0.89	0.94	0.98	0.44	0.58	0.93	0.87	0.85	0.95	0.97	0.88	0.92	0.97	0.97	0.83	0.87
7 (2.13)	84 (213)	0.75	0.52	0.41	0.82	0.96	0.75	0.86	0.92	0.97	0.38	0.51	0.89	0.82	0.78	0.92	0.95	0.83	0.89	0.95	0.95	0.76	0.81
8 (2.44)	96 (244)	0.71	0.47	0.35	0.79	0.94	0.72	0.84	0.91	0.96	0.33	0.46	0.85	0.76	0.71	0.88	0.92	0.79	0.85	0.92	0.92	0.68	0.76
9 (2.74)	108 (274)	0.69	0.43	0.32	0.77	0.93	0.69	0.82	0.89	0.95	0.30	0.42	0.81	0.70	0.64	0.85	0.90	0.74	0.81	0.90	0.90	0.61	0.70
10 (3.05)	120 (305)	0.66	0.40	0.29	0.75	0.92	0.66	0.80	0.87	0.94	0.28	0.40	0.78	0.65	0.57	0.82	0.87	0.69	0.78	0.87	0.87	0.54	0.64
12 (3.66)	144 (366)	0.61	0.36	0.25	0.70	0.89	0.60	0.76	0.84	0.91	0.24	0.36	0.70	0.54	0.45	0.76	0.82	0.60	0.71	0.82	0.83	0.43	0.53
14 (4.27)	168 (427)	0.55	0.32	0.23	0.66	0.86	0.55	0.73	0.81	0.89	0.22	0.32	0.63	0.45	0.38	0.70	0.78	0.51	0.64	0.77	0.78	0.35	0.45
16 (4.88)	192 (488)	0.51	0.30	0.21	0.62	0.84	0.50	0.69	0.78	0.87	0.21	0.30	0.56	0.39	0.32	0.64	0.73	0.44	0.57	0.72	0.73	0.30	0.39
18 (5.49)	216 (549)	0.47	0.28	0.19	0.58	0.81	0.47	0.65	0.75	0.84	0.19	0.28	0.49	0.34	0.28	0.58	0.68	0.39	0.50	0.67	0.68	0.27	0.34
20 (6.10)	240 (610)	0.44	0.26	0.18	0.54	0.78	0.43	0.61	0.72	0.82	0.18	0.26	0.44	0.31	0.25	0.52	0.63	0.35	0.45	0.62	0.63	0.24	0.30

BEARING LOADS ON UNISTRUT CHANNEL

Channel	Bearing Length 1½" (41 mm) Maximum Allowable Loads Lbs (kN)		Bearing Length 1½" (41 mm) Maximum Allowable Loads Lbs (kN)		Bearing Length 3¼" (82 mm) Maximum Allowable Loads Lbs (kN)	
	P1000	6,700 29.80	3,100 13.79	7,700 34.25	P1100	3,500 15.57
P2000	2,500 11.12	1,200 5.34	3,000 13.34	P3000	6,700 29.80	7,700 34.25
P3000	6,700 29.80	3,200 14.23	7,700 34.25	P3300	6,800 30.25	7,800 34.70
P4000	2,600 11.57	1,200 5.34	3,000 13.34	P4100	3,500 15.57	4,100 18.24
P4100	3,500 15.57	1,800 8.01	4,100 18.24	P4400	7,300 32.47	8,400 37.37
P4400	7,300 32.47	3,400 15.12	8,400 37.37	P4520	7,300 32.47	8,400 37.37
P4520	7,300 32.47	3,400 15.12	8,400 37.37	P5000	6,500 28.91	7,500 33.36
P5000	6,500 28.91	3,000 13.34	7,500 33.36	P5500	6,600 29.36	7,600 33.81
P5500	6,600 29.36	3,100 13.79	7,600 33.81			